

QUALITY

CHAIN CORP

WWW.QUALITYCHAINCORP.COM

Visit For: Real-Time Tire Fitments
Installation Instructions / Videos
General Information

PHONE: (503) 614-9664 / TOLL FREE: (800) 843-8824
FAX: (503) 614-8812



QUALITY CHAIN CORP HEAD OFFICE

3365 N.W. 215th Ave. Hillsboro, OR 97124



QUALITY CHAIN ROCKLIN

3735 Cincinnati Ave. Suite 300 Rocklin, CA 95765

TIRE CHAINS FOR ALL YOUR NEEDS

**"PRODUCTS AND
SERVICE
SECOND TO NONE"**

QCC also has warehouses in:

- Sparks, NV
- Denver, CO
- Salt Lake City, UT
- Harrisburg, PA
- Surrey, BC Canada

CAT-2012

Effective Date June 2011

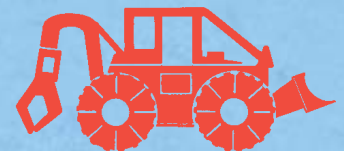
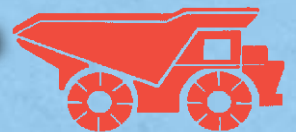
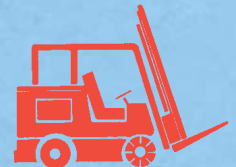

*Check out our
new VOLT cable
chains inside!*

STANDARD CHAIN SPECS

PASSENGER

LIGHT TRUCK / SUV

TRUCK

PART NUMBER	X-CHAIN PER 1/2 PR.	X-CHAIN DIA.	LINKS PER CROSS	X-CHAIN LENGTH	SIDE CHAIN LENGTH
1114	10	0.177	7	10.38"	53.8"
1118	11	0.177	7	10.38"	58.8"
1122	12	0.177	7	10.38"	63.8"
1126	11	0.177	8	11.56"	58.8"
1130	12	0.177	8	11.56"	63.8"
1134	12	0.177	9	12.74"	63.8"
1138	13	0.177	9	12.74"	68.8"
1142	13	0.177	10	13.92"	68.8"
1206,1806	10	0.207	7	10.18"	55.6"
1210,1810	12	0.207	7	10.18"	66.8"
1217,1817	11	0.207	7	10.18"	63.1"
1230,1830	11	0.207	9	12.03"	60.9"
1240,1840	12	0.207	9	12.03"	66.1"
1250,1850	13	0.207	10	12.97"	71.3"
1254,1854	12	0.207	10	12.97"	66.1"
2209, 2809	11	0.234	9	12.12"	62.6"
2211, 2811	13	0.234	9	12.12"	73.7"
2214, 2214QC, 2814, 2814QC	15	0.234	10	13.12"	87.8"
2216, 2216QC, 2816, 2816QC	12	0.234	10	13.12"	70.9"
2219, 2219QC, 2819, 2819QC	13	0.234	10	13.12"	76.5"
2221, 2221QC, 2821, 2821QC	14	0.234	10	13.12"	82.0"
2226, 2226QC	15	0.234	14	17.12"	87.6"
2228, 2228QC, 2828, 2828QC	14	0.234	12	15.12"	82.0"
2229, 2229QC, 2829, 2829QC	12	0.234	12	15.12"	70.9"
2237, 2837	12	0.281	9	14.37"	92.4"
2435HH	9	0.312	8	14.62"	72.8"
2437HH	10	0.312	8	14.62"	79.3"
3210	13	0.234	12	15.12"	76.5"
3227	10	0.281	10	15.62"	77.9"
3229	10	0.281	12	18.12"	77.9"
3235	12	0.281	12	18.12"	92.3"
3237	9	0.281	16	23.20"	70.7"
4219, 4219QC, 4819, 4819QC	26	0.234	10	13.12"	76.5"
4221, 4221QC, 4821, 4821QC	28	0.234	10	13.12"	82.0"
4237, 4837	24	0.281	9	14.37"	92.4"
2145SLC	15	0.281	9	14.60"	106.5"
2147SLC	13	0.281	11	16.75"	100.0"
2149SLC	15	0.281	11	16.75"	115.6"
2150RHD	14	0.312	11	17.00"	115.6"
2239, 2239QC, 2839, 2839QC	13	0.281	9	14.37"	98.8"
2241, 2241QC, 2841, 2841QC	14	0.281	9	14.37"	106.5"
2245, 2245QC, 2845, 2845QC	15	0.281	9	14.37"	113.3"
2247, 2247QC, 2847, 2847QC	14	0.281	10	15.62"	106.5"
2249, 2249QC, 2849, 2849QC	15	0.281	10	15.62"	115.6"
2251, 2251QC, 2851, 2851QC	14	0.312	9	15.99"	114.0"
2255, 2255QC, 2855, 2855QC	14	0.312	10	17.40"	115.9"
2257, 2857	16	0.312	10	17.40"	128.7"

TRUCK

TRACTOR

LOADER / GRADER

PART NUMBER	X-CHAIN PER 1/2 PR.	X-CHAIN DIA.	LINKS PER CROSS	X-CHAIN LENGTH	SIDE CHAIN LENGTH
2271, 2871	16	0.312	11	18.79"	131.1"
2273, 2873	18	0.312	11	18.79"	144.1"
2441HH	11	0.375	11	17.36"	88.8"
2445HH	12	0.375	11	17.36"	97.1"
2448HH	13	0.375	11	17.36"	103.9"
2452HH	14	0.375	11	17.36"	110.2"
3255	14	0.281	13	21.57"	106.8"
3261	16	0.312	14	22.96"	121.3"
3269	13	0.312	15	24.35"	99.7"
3273	12	0.312	20	31.30"	92.4"
4141SLC	28	0.281	9	14.60"	106.5"
4145SLC	30	0.281	9	14.60"	113.3"
4147SLC	26	0.281	11	16.75"	100.0"
4149SLC	30	0.281	11	16.75"	115.6"
4150RHD	28	0.312	11	17.00"	115.6"
4239, 4239QC, 4839, 4839QC	26	0.281	9	14.37"	98.8"
4241, 4241QC, 4841, 4841QC	28	0.281	9	14.37"	106.5"
4245, 4245QC, 4845, 4845QC	30	0.281	9	14.37"	113.3"
4247, 4247QC, 4847, 4847QC	28	0.281	10	15.62"	106.5"
4249, 4249QC, 4849, 4849QC	30	0.281	10	15.62"	115.6"
4251, 4851	28	0.312	9	16.01"	114.0"
4255, 4855	28	0.312	10	17.40"	115.9"
4435HH	22	0.375	11	17.36"	86.4"
4437HH	24	0.375	11	17.36"	94.1"
4448HH	26	0.375	11	17.36"	101.8"
4461HH	28	0.375	11	17.36"	115.3"
0822	11	0.375	11	17.36"	88.4"
0832	12	0.375	11	17.36"	96.1"
0836	12	0.375	14	21.14"	96.1"
0838	14	0.375	14	21.14"	111.4"
0850	10	0.375	16	23.66"	80.7"
0852	13	0.375	14	21.14"	105.7"
0856	15	0.375	14	21.14"	119.1"
0859	15	0.375	16	23.66"	121.0"
0862	18	0.375	14	21.14"	146.0"
0866	19	0.375	16	23.66"	149.8"
0869	16	0.375	16	23.66"	128.7"
0874	15	0.375	19	27.44"	121.0"
0876	16	0.375	19	27.44"	130.6"
0877	17	0.375	19	27.44"	136.4"
0879	18	0.375	19	27.44"	146.0"
0880	20	0.375	19	27.44"	157.5"
0882	12	0.437	17	31.29"	110.7"
0883	13	0.437	17	31.29"	121.6"
0885	15	0.437	17	31.29"	136.8"
0887	16	0.437	17	31.29"	145.5"
0889	17	0.437	17	31.29"	154.1"
0891	14	0.437	22	39.09"	128.1"
0893	16	0.437	22	39.09"	143.3"
2612	14	0.375	17	25.00"	114.6"
2615	16	0.375	17	25.00"	126.1"
2624	13	0.437	15	28.18"	121.5"
2627	15	0.437	15	28.18"	138.9"
2633	14	0.437	19	34.43"	123.0"
2636	15	0.437	19	34.43"	138.9"
2645	15	0.531	20	39.25"	143.7"
2648	16	0.531	20	39.25"	152.7"

Warning Read Before Use

Warning Information For Tire Chains, Tires and Wheels

- WARNING** - Traction device may cause cosmetic scuffing on tires when installed. This condition is unavoidable on certain tread types and tire designs.
- WARNING** - Wheels are also at risk of cosmetic scuffing with the use of traction devices. Wheels using low profile tires such as 35, 40, 45 and 50 series tires are at higher risk due to the short height of the tire sidewall.
- WARNING** - Traction devices must hang down over the sidewall of the tire in order to stay on the tire while being used.
- WARNING** - Vehicles components such as ABS sensors, brake lines, etc... can be damaged if the traction device strikes the components. Pre-fit traction device before use and check clearance.
- WARNING** - Traction devices can break during the course of their normal and extreme service life.
(If traction device breaks, remove immediately)
- WARNING** - Traction devices are designed for snow or ice covered road surfaces, not bare pavement. Traction devices on bare pavement increase the wear and chance of component failure.
- WARNING** - Traveling at speeds faster than 30 MPH also increase the chance of component failure.
- WARNING** - Using traction devices with component failure is extremely unsafe and may cause loss of control or damage to the vehicle. **(If traction device breaks, remove immediately)**
- WARNING** - Traction devices that have been broken should immediately be repaired or replaced in a safe place.
- WARNING** - The use of traction devices are at the risk of the vehicle operator.
- WARNING** - Vehicle operators unwilling to accept the possible risks with the use of any traction device installed on their vehicle such as, but not limited to, accident, vehicle damage, tire damage or wheel damage, should not use any traction device on their vehicle.
Under no circumstances will compensation for damage be considered by QCC where the damage is said to have resulted from the use of any traction device.

WARRANTIES

1. **DISCLAIMER OF WARRANTIES:** The products listed in this catalog are warranted free from defects in workmanship and material for thirty (30) days from date of delivery. No other express warranty is given and no affirmation of seller, by words or action, shall constitute a warranty.
2. The above warranty is made only to the dealer, retailer or other direct customer of Quality Chain Corp. (hereby referred to as QCC). QCC makes no warranty to the ultimate user and prohibits the transfer of the warranty given above to its direct customer to any subsequent purchaser, including but not limited to ultimate user.
3. **REMEDIES:** The Buyer's sole remedy for breach of any warranty is limited exclusively to obtaining, at the discretion of the Seller, either credit, repair or replacement of any product sold hereunder by QCC which shall be returned to seller's plant, transportation prepaid within thirty (30) days after delivery to a user and within ten (10) days of discovery of alleged defect, and which QCC inspection shall determine to be defective. Buyer shall not be entitled to recover any incidental or consequential damages. No material shall be returned without written consent of the seller.

TERMS: Net 30

FREIGHT TERMS: Actual freight will be prepaid or allowed at lowest published tariff station-to-station rates on all shipments of 1000 pounds or more in one shipment to jobber's regularly established place of business, or to Federal, State, County and Town Governments or Agencies, or to semi-wholesalers or large fleet operators. SHIPMENTS OF LESS THAN 1000 POUNDS SHIPPED FREIGHT COLLECT. On drop shipments, direct from factory or warehouse to dealer for jobber's account, a service charge will be added to our net billing. Promptly inventory each shipment upon receipt, misshipment claims must be submitted within 24 hours of receipt of shipment. Claims will not be considered unless an exception is noted on the Original Freight Bill.

MINIMUM CHARGE: \$18.00 per order. Small package shipments (UPS, Fedex, USPS, etc...) have a \$5.00 handling fee.

PRICES: Orders accepted will be subject to prices prevailing at time of shipment. Subject to change without notice.

RETURN MERCHANDISE: No merchandise will be accepted without prior written authorization. All return merchandise must be shipped freight prepaid. Collect shipments will be refused. A 20% restock/handling charge will be deducted from the credit amount.

TABLE OF CONTENTS

ISO 9002
CERTIFIED

FIT CHARTS

Passenger	5-11
Light Truck	16-21
Truck	29-30
Loader, Grader and Tractor	39-41

PREMIUM FIT CHART

Premium Light Truck	57-61
Premium Truck	64-65
Premium Loader, Grader and Tractor	69-71

PASSENGER TIRE CHAIN

Volt Cable, High Volt Cable (QV300, QV500)	12
Cobra Cable, Lightning Cable (1000, A1000)	13
PL, Regular and V-Bar (1100, 1200, 1800)	14
Diamond Back (1500Q)	15

LIGHT TRUCK CHAIN & SUV

Volt LT Cable, High Volt Cable (QV700, QV500)	22
Cobra Jr. Cable, Lightning LT (1600, A2000)	23
Diamond Hoop Style Lightweight (2300LW)	24
Diamond Hoop Style Regular (2500Q)	25
Regular And V-Bar Link Single and Dual/Triple Regular and Cam (2200, 4200, 2800, 4800)	26
Dual and Wide Base, Square Link, V-Bar (3200, 3800, 3100SLC, 3100RHD)	27
Square Link Light Truck, Mud Service (2100SLC, 2100RHD, 2400HH, 4400HH)	28

TRUCK CHAIN

Volt Truck, Single And Wide Base (QV800)	32
Cobra Cam Cable (2300, 4300, 3000)	33
Link Single And Dual Triple - Regular And V-Bar Cam (2200, 4200, 2800, 4800)	34
Long Mileage, Extra Durable Alloy Cam And Mud Service (2200LMC, 2200XDQC, 2400HH, 4400HH)	35
Square Link Regular, Heavy Duty And Twisted (2100SLC, 2100RHD, 4100SLC, 4100RHD, 2100TWIST)	36
Wide Base Regular, Long Mileage, And Square Link (3200, 3200LMC, & 3100SLC)	37
Logging And Mining, Square Link, V-Bar, Long Mileage (2100LS 4100LS, 2800LS, 4800LS, 2200LMC, 4200LMC) ..	38

LOADER / GRADER

Ladder Type Regular, V-Bar, Premium, Square Link Ladder (2600, 2600V, A2600, A2600V, 6500)	42
Premium Square Link Ladder, Square Link Ladder U-Grip (6500N, 6500U)	43
Alloy Maxtrac, Alloy Maxtrac U-Grip (8100MT, 8600MT, 8100MTU, 8600MTU)	44
Diamond Back Alloy Square Link, U-Grip, Link Over Link, Wear Bar (2700DP, 2700DPU, 2700WDP, 2700WB)	45
Megatrac, Megatrac U-Grip (2700, 2700U)	46
Qualtrax Diamond Pattern, Wear Bar, Double Diamond, Double Diamond Wear Bar (DRQ, WBQ, DRSQ, WBSQ) ..	47

TRACTOR CHAIN / SNOW BLOWER / GARDEN TRACTOR / FORKLIFT / SKID STEER / ATV / SKIDDER

Field Master / Premium, Duo Grip / Premium (0800, A0800, DUO, ADUO)	48-49
Garden Tractor, Snow Blower, Forklift, Skid Steer, ATV (1300, 1400, 1500, ATV)	50-53
Skidder - Ring, Net, U-Grip (RC, RA, RAT, RAM, NC, NCU, NCUT, NN, NNU)	54-55

PREMIUM PASSENGER / LIGHT TRUCK & SUV

Quick TRAK / Spikes-Spider (P200, LT, SS)	56
Regular Link Single And Dual/Triple Regular And Cam (A2200, A4200)	61
V-Bar Link Single And Dual/Triple And Cam, Texas Long Horn (A2800, A4800, 3100U, 4100U)	62
Qualtrax T2 And Rallye, Studded Single And Dual/Triple (200, 3900N, 4900N)	63

PREMIUM TRUCK

Regular And V-Bar Link Single and Dual/Triple Regular and Cam (A2800, A4800, A2200, A4200)	66
Mud Service And Texas Long Horn (A2400, A4400, 3100U, 4100U)	67
Studded Single and Dual/Triple And Qualtrax Rallye, Snow Trax, Polar-S (35/3900N, 45/4900N, 300, 400)	68

PREMIUM LOADER/GRADER/SKIDDER/TRACTOR

Studded Ladder and H-Pattern (9900, 2900, 8200, 8300, 8400)	72
---	----

(CONTINUED ON NEXT PAGE)

TABLE OF CONTENTS (continued)

ACCESSORIES

Continuous Cross Chain, Side Chain, Hooks, Fasteners, Pliers, Shackles, Spider Bungees, Adjusters, Etc 75-79
 Replacement Cross Chain 79-84

INDUSTRIAL / TRANSPORT / HARDWARE / BINDERS

Continuous System 3, 4, 7, 8 85-86
 Chain Assemblies 86
 Binders, Grab Hooks 87

INFORMATIONAL

State Chain Requirements 31
 Standard Chain Specifications 2
 Warnings, Warranties & Terms 3

TIRE SIZE FITTING Chain stock numbers have been designed to fit a range of tire sizes. A variance in fit will occur for each tire size within the range. Chains must be installed and examined for proper fit prior to use on snow and icy road conditions.

PASSENGER TIRE CHAIN FIT CHART (CONTINUED ON NEXT PAGE)

THIS IS A GUIDE ONLY — ACTUAL FITMENT MAY VARY / CLEARANCES VARY, PLEASE CHECK

RIM SIZE	TIRE SIZE	VOLT	HIGH VOLT	COBRA	LIGHTNING	DIAMOND	TYPE	CAR	V-BAR
		QV300	QV500	CABLE	CABLE	BACK	"PL"	CHAIN	CHAIN
		Pg.# 12	Pg.# 12	1000	A1000	1500Q	1100	1200	1800
		Class (S)	Class (S)	Class (S)	Class (S)	Class (S)	Class (S)	Class (U)	Class (U)
12"	145/80-12			1014			1110		
	215/50-13			1018			1118	1210	1810
13"	235/50-13	QV323	QV539	1034			1134	1230	1830
	245/50-13			1034			1134	1230	1830
	195/55-13	QV315				1515Q			
	155/60-13					1505Q			
	165/60-13			1014	A1014	1505Q	1114	1206	1806
	175/60-13			1014	A1014	1510Q	1114	1206	1806
	185/60-13			1018	A1018	1515Q	1118	1210	1810
	195/60-13			1026	A1018	1520Q	1126	1230	1830
	205/60-13	QV319	QV539	1026	A1022	1525Q	1126	1230	1830
	215/60-13	QV323	QV539	1026	A1026	1530Q	1126	1230	1830
	225/60-13	QV323	QV539						
	235/60-13			1034	A1030	1535Q	1134	1230	1830
	145/65-13							1210	1810
	165/65-13			1018	A1014	1510Q	1118	1206	1806
	175/65-13					1515Q			
	185/65-13			1014	A1018	1520Q	1114		
	195/65-13			1026	A1022	1525Q	1126		
	205/65-13					1530Q			
	215/65-13			1030	A1026		1130		
	145/70-13			1014		1505Q	1110		
	155/70-13			1014	A1014	1510Q	1114	1206	1806
	165/70-13			1014	A1014	1515Q	1114	1206	1806
	175/70-13	QV315		1018	A1018	1520Q	1118	1210	1810
	185/70-13			1026	A1022	1525Q	1126	1230	1830
	195/70-13			1026	A1022	1530Q	1126	1230	1830
	205/70-13	QV327	QV539	1030	A1026	1535Q	1130	1230	1830
	165/75-13			1014	A1018	1515Q	1114	1217	1817
	175/75-13			1018	A1018	1525Q	1118		
	185/75-13			1026	A1022	1525Q	1126	1230	1830
	195/75-13			1026	A1022	1525Q	1126		
	135/80-13						1110	1206	1806
	145/80-13			1014	A1014	1510Q	1114	1206	1806
	155/80-13			1014	A1014	1515Q	1114	1217	1817
	165/80-13			1018	A1018	1520Q	1118	1230	1830
	175/80-13			1022	A1022	1525Q	1122	1230	1830
	185/80-13			1026	A1022	1530Q	1126	1230	1830

THIS IS A GUIDE ONLY — ACTUAL FITMENT MAY VARY / CLEARANCES VARY , PLEASE CHECK

RIM SIZE	TIRE SIZE	VOLT QV300	HIGH VOLT QV500	COBRA CABLE 1000	LIGHTNING CABLE A1000	DIAMOND BACK 1500Q	TYPE "PL" 1100	CAR CHAIN 1200	V-BAR CHAIN 1800
		Pg.# 12 Class (S)	Pg.# 12 Class (S)	Pg.# 13 Class (S)	Pg.# 13 Class (S)	Pg.# 15 Class (S)	Pg.# 14 Class (S)	Pg.# 14 Class (U)	Pg.# 14 Class (U)
13"	185/85-13			1030	A1026		1130		
	185/50-14				A1014	1515Q			
14"	205/50-14	QV319							
	215/50-14	QV323	QV539						
	225/50-14	QV323	QV539						
	235/50-14	QV323	QV539						
	245/50-14			1034	A1026	1540Q	1134		
	265/50-14			1042	A1038	1545Q	1142		
	175/55-14	QV311							
	185/55-14	QV315		1018	A1018	1515Q	1118		
	195/55-14	QV319		1022	A1022	1525Q	1122	1217	1817
	205/55-14	QV323	QV539	1026	A1022	1525Q	1126	1230	1830
215/55-14	QV323	QV539							
225/55-14	QV327	QV539	1034	A1034	1535Q	1134	1230	1830	
255/55-14			1038	A1038		1138			
165/60-14			1014	A1014	1515Q	1114			
175/60-14			1018	A1018	1515Q	1118	1217	1817	
185/60-14	QV319		1018	A1022	1520Q	1118	1230	1830	
195/60-14			1026	A1022	1525Q	1126	1230	1830	
205/60-14	QV323	QV539	1026	A1026	1530Q	1126	1230	1830	
215/60-14	QV323	QV539	1030	A1030	1535Q	1130	1240	1840	
225/60-14	QV327	QV547	1030	A1030	1540Q	1130	1254	1854	
235/60-14	QV335	QV555	1034	A1034	1545Q	1134	1254	1854	
245/60-14	QV335	QV555	1038	A1038	1547Q	1138			
255/60-14	QV343	QV555	1038	A1042	1550Q	1138			
265/60-14			1042	A1046		1142			
275/60-14	QV339	QV563	1042	A1042		1142			
155/65-14			1014	A1014	1510Q	1114			
165/65-14	QV315		1018	A1018	1515Q	1118	1206	1806	
175/65-14	QV315		1018	A1018	1520Q	1118	1217	1817	
185/65-14	QV319	QV539	1026	A1022	1525Q	1126	1230	1830	
195/65-14			1026	A1026	1530Q	1126	1230	1830	
205/65-14			1030	A1026	1535Q	1130	1240	1840	
215/65-14	QV331	QV547	1034	A1030	1540Q	1134	1240	1840	
225/65-14			1034	A1034	1540Q	1134	1254	1854	
145/70-14			1014	A1014	1510Q	1114			
155/70-14			1018	A1018	1515Q	1118			
165/70-14			1018	A1018	1520Q	1118	1217	1817	
175/70-14	QV319	QV539	1026	A1022	1525Q	1126	1217	1817	
185/70-14	QV323	QV539	1026	A1026	1530Q	1126	1230	1830	
195/70-14	QV327	QV547	1030	A1026	1535Q	1130	1240	1840	
205/70-14	QV329	QV547	1034	A1030	1540Q	1134	1240	1840	
215/70-14	QV335	QV547	1034	A1034	1545Q	1134	1254	1854	
225/70-14	QV335	QV555	1038	A1038	1545Q	1138	1254	1854	
235/70-14	QV339	QV563	1038	A1042	1550Q	1138	1250	1850	
245/70-14			1042	A1046	1555Q	1142			
165/75-14			1018	A1022	1525Q	1118	1217	1817	
175/75-14			1022	A1022	1525Q	1122	1230	1830	
185/75-14			1026	A1026	1530Q	1126	1240	1840	
195/75-14			1030	A1030	1535Q	1130	1240	1840	
205/75-14	QV331	QV555	1034	A1030	1540Q	1134	1240	1840	
215/75-14	QV335	QV555	1034	A1038	1545Q	1138	1254	1854	

THIS IS A GUIDE ONLY.

ACTUAL FITMENT MAY VARY AND CLEARANCES

PLEASE CHECK

THIS IS A GUIDE ONLY — ACTUAL FITMENT MAY VARY / CLEARANCES VARY , PLEASE CHECK

RIM SIZE	TIRE SIZE	VOLT QV300	HIGH VOLT QV500	COBRA CABLE 1000	LIGHTNING CABLE A1000	DIAMOND BACK 1500Q	TYPE "PL" 1100	CAR CHAIN 1200	V-BAR CHAIN 1800
		Pg.# 12	Pg.# 12	Pg.# 13	Pg.# 13	Pg.# 15	Pg.# 14	Pg.# 14	Pg.# 14
		Class (S)	Class (S)	Class (S)	Class (S)	Class (S)	Class (S)	Class (U)	Class (U)
14"	225/75-14	QV339	QV563	1038	A1038	1550Q	1138	1250	1850
	165/80-14			1018	A1022	1525Q	1118	1217	1817
	175/80-14			1022	A1022		1122		
	185/80-14			1030	A1026	1535Q	1130	1240	1840
	285/40-15			1038	A1038		1138		
15"	195/45-15			1026	A1026	1520Q	1126		
	220/45-15			1026	A1026		1126	1230	1830
	195/50-15	QV319	QV539	1026	A1022	1525Q	1126	1230	1830
	205/50-15	QV323	QV539	1026	A1022	1525Q	1126	1230	1830
	215/50-15	QV323	QV539	1026	A1026	1535Q	1126	1230	1830
	225/50-15	QV327	QV539	1030	A1030	1535Q	1130	1230	1830
	235/50-15	QV327	QV547						
	245/50-15	QV331	QV555	1038	A1034		1138		
	265/50-15			1042	A1042	1553Q	1142		2829
	275/50-15	QV339	QV555	1042	A1042	1555Q	1142		
	295/50-15			1046	A1046		1146		
	175/55-15	QV315		1018	A1018	1520Q	1118		
	185/55-15	QV319	QV539	1022	A1022	1525Q	1122	1217	1817
	195/55-15	QV323	QV539	1022	A1022	1525Q	1122	1230	1830
	205/55-15	QV327	QV539	1034	A1026	1535Q	1134	1230	1830
	215/55-15	QV327	QV539	1034	A1034	1535Q	1134		
	225/55-15		QV547	1034	A1034	1540Q	1134		
	235/55-15	QV335	QV555	1034	A1034	1545Q	1134		
	155/60-15	QV311							
	165/60-15			1018	A1018	1520Q	1118		
	175/60-15			1018	A1018	1525Q	1118		
	185/60-15	QV323	QV539	1026	A1022	1525Q	1126	1230	1830
	195/60-15	QV327	QV539	1030	A1026	1530Q	1130	1230	1830
	205/60-15	QV329	QV547	1030	A1030	1535Q	1130	1240	1840
	215/60-15	QV331	QV547	1034	A1034	1540Q	1138	1240	1840
	225/60-15	QV331	QV547	1034	A1034	1547Q	1134		
	235/60-15	QV335	QV555	1038	A1038	1550Q	1138		
	245/60-15	QV339	QV555	1042	A1042	1553Q	1142		
	255/60-15			1042	A1046	1555Q	1142		
	265/60-15			1042	A1046		1142		
	275/60-15			1046	A1046	1555Q	1146		2829
	165/65-15			1022	A1022	1525Q	1122	1217	1817
	175/65-15	QV319	QV539	1022	A1022	1525Q	1122		
	185/65-15	QV323	QV539	1030	A1026	1530Q	1130	1230	1830
	190/65-15			1030	A1030	1530Q	1130	1230	1830
	195/65-15	QV329	QV547	1030	A1030	1535Q	1130	1230	1830
	205/65-15	QV329	QV547	1034	A1030	1540Q	1134	1254	1854
	215/65-15	QV335	QV555	1038	A1038	1545Q	1138	1254	1854
	225/65-15	QV339	QV555	1038	A1038		1138		
	235/65-15	QV339	QV563	1042	A1042	1555Q	1142		
	245/65-15	QV343	QV563	1046	A1046		1146		
	255/65-15	QV343	QV563	1042	A1042		1142		
	145/70-15			1018	A1018	1515Q	1118		
	155/70-15			1018	A1018	1520Q	1118		
	165/70-15			1022	A1022	1525Q	1122		
	175/70-15			1022	A1026	1530Q	1122		
	185/70-15			1030	A1026	1535Q	1130	1240	1840

PASSENGER TIRE CHAIN FIT CHART

(CONTINUED ON NEXT PAGE)

THIS IS A GUIDE ONLY — ACTUAL FITMENT MAY VARY / CLEARANCES VARY , PLEASE CHECK

RIM SIZE	TIRE SIZE	VOLT QV300	HIGH VOLT QV500	COBRA CABLE 1000	LIGHTNING CABLE A1000	DIAMOND BACK 1500Q	TYPE "PL" 1100	CAR CHAIN 1200	V-BAR CHAIN 1800
		Pg.# 12 Class (S)	Pg.# 12 Class (S)	Pg.# 13 Class (S)	Pg.# 13 Class (S)	Pg.# 15 Class (S)	Pg.# 14 Class (S)	Pg.# 14 Class (U)	Pg.# 14 Class (U)
15"	195/70-15	QV329	QV547	1034	A1030	1540Q	1134	2209LMC	1840
	205/70-15	QV335	QV555	1034	A1034	1545Q	1134	1250	1850
	215/70-15	QV335	QV555	1038	A1038	1550Q	1138	1250	1850
	225/70-15	QV339	QV563	1038	A1042	1553Q	1138	1250	1850
	235/70-15	QV343	QV563	1042	A1046	1555Q	1142	1250	1850
	245/70-15	QV343	QV563	1042	A1046	1553Q	1142		
	255/70-15			1046	A1046	1555Q	1146		
	175/75-15			1022	A1026	1535Q	1122		
	185/75-15			1026	A1030	1535Q	1130	1230	1830
	195/75-15	QV335		1030	A1034	1540Q	1130	1240	1840
15"	205/75-15	QV335	QV555	1034	A1038	1547Q	1138	1250	1850
	215/75-15	QV339	QV571	1038	A1038	1550Q	1138	1250	1850
	225/75-15	QV343	QV563	1042	A1042	1555Q	1142	1250	1850
	235/75-15		QV571	1042	A1046	1555Q	1142	1250	1850
	145/80-15			1018	A1022		1118		
	155/80-15			1022	A1022		1122	1230	1830
	165/80-15			1022	A1026	1530Q	1122		
	195/80-15	QV335	QV563	1034	A1034	1545Q	1134	1250	1850
	205/80-15.5	QV339	QV563						
	215/80-15	QV343	QV563						
15"	225/80-15			1042	A1046		1142		
	215/85-15	QV343	QV575						
16"	215/40-16	QUICKTRAK OR SPIKES-SPIDER RECOMMENDED SEE WEBSITE FOR FITMENTS							
	205/40-16			1026	A1022	1525Q	1126		
	205/45-16	QV323	QV539	1030	A1030	1525Q	1130		
	215/45-16	QV323	QV539	1030	A1030	1535Q	1130		
	225/45-16			1034	A1038	1540Q	1134		
	245/45-16			1038	A1038		1138		
	255/45-16	QV335	QV555						
	195/50-16	QV323	QV539	1030	A1030		1130		
16"	205/50-16	QV327	QV539	1034	A1026	1535Q	1134	1230	1830
	215/50-16	QV323	QV539	1034	A1034		1134		
	225/50-16	QV331	QV547	1034	A1034	1545Q	1134	1240	1840
	235/50-16	QV335	QV555						
	245/50-16	QV339	QV555	1038	A1042	1555Q	1138		
	255/50-16	QV343	QV555	1042	A1042	1555Q	1142		
	265/50-16	QV343	QV555	1042	A1042		1142		2829
	175/55-16	QV319	QV539						
	185/55-16			1030		1535Q	1130		
	195/55-16	QV323	QV539	1030	A1030		1130		
16"	205/55-16	QV331	QV547	1034	A1030	1540Q	1134	1230	1830
	215/55-16	QV331	QV547	1034	A1034	1545Q	1134		
	225/55-16	QV335	QV555	1038	A1038	1547Q	1138	1254	1854
	235/55-16	QV339	QV555	1038	A1042		1138		
	245/55-16		QV555	1042	A1042		1142		
	255/55-16	QV343	QV563	1042	A1042	1555Q	1142		
	195/60-16	QV329	QV547	1030	A1030	1535Q	1130		
	205/60-16	QV329	QV547	1034	A1034		1138	1240	1840
	215/60-16	QV335	QV555	1038	A1038	1545Q	1138	1254	1854
	220/60-16	QV339	QV555						
16"	225/60-16	QV339	QV555	1038	A1042	1550Q	1138	1254	1854
	235/60-16	QV339	QV563	1042	A1042	1553Q	1142		

THIS IS A GUIDE ONLY. ACTUAL FITMENT MAY VARY AND CLEARANCES VARY, PLEASE CHECK

THIS IS A GUIDE ONLY — ACTUAL FITMENT MAY VARY / CLEARANCES VARY , PLEASE CHECK

RIM SIZE	TIRE SIZE	VOLT QV300	HIGH VOLT QV500	COBRA CABLE 1000	LIGHTNING CABLE A1000	DIAMOND BACK 1500Q	TYPE "PL" 1100	CAR CHAIN 1200	V-BAR CHAIN 1800	
		Pg.# 12 Class (S)	Pg.# 12 Class (S)	Pg.# 13 Class (S)	Pg.# 13 Class (S)	Pg.# 15 Class (S)	Pg.# 14 Class (S)	Pg.# 14 Class (U)	Pg.# 14 Class (U)	
16"	245/60-16	QV343	QV563	1042	A1046		1142			
	255/60-16	QV343	QV555							
	185/65-16	QV329	QV547							
	195/65-16	QV329	QV547	1034	A1034		1134			
	205/65-16	QV335	QV555	1038	A1038		1138	1254	1854	
	215/65-16	QV335	QV555	1038	A1038	1550Q	1138	1254	1854	
	225/65-16	QV339	QV563	1038	A1042	1553Q	1138			
	235/65-16	QV343	QV563	1042	A1042	1555Q	1142			
	245/65-16	QV343	QV563							
	205/70-16	QV335	QV555	1038	A1038	1547Q	1138			
16"	215/70-16	QV339	QV563	1038	A1042	1550Q	1138	1254	1854	
	225/70-16	QV343	QV571	1046	A1046		1146			
	165/75-16					1530Q				
	175/75-16					1540Q				
	215/75-16	QV343	QV571	1042	A1042		1142			
	225/75-16		QV571	1042	A1046		1142			
	195/80-16	QV339	QV563							
	205/80-16	QUICKTRAK OR SPIKES-SPIDER RECOMMENDED SEE WEBSITE FOR FITMENTS								
	215/80-16	QV343	QV575							
	17"	335/35-17	QUICKTRAK OR SPIKES-SPIDER RECOMMENDED SEE WEBSITE FOR FITMENTS							
285/35-17		QUICKTRAK OR SPIKES-SPIDER RECOMMENDED SEE WEBSITE FOR FITMENTS								
205/40-17				1026	A1026		1126			
215/40-17				1034	A1030		1134			
235/40-17				1034	A1034	1540Q	1134			
245/40-17		QV331	QV555	1038	A1038	1547Q	1138			
255/40-17			QV555	1038	A1038	1547Q	1138			
275/40-17				1042	A1042	1553Q	1142			
285/40-17				1046	A1046		1146			
205/45-17		QV327	QV539	1030	A1030		1130			
17"	215/45-17		QV547	1030	A1030	1540Q	1130			
	225/45-17		QV547	1034	A1034	1545Q	1134			
	235/45-17		QV555	1038	A1038	1545Q	1138			
	245/45-17		QV555	1042	A1042	1547Q	1138			
	255/45-17	QV339	QV555	1042	A1042	1553Q	1142			
	205/50-17	QV331	QV547	1034	A1038	1545Q	1134			
	215/50-17	QV331	QV547	1038	A1038	1547Q	1138	1240	1840	
	225/50-17	QV335	QV555	1038	A1038	1547Q	1138			
	235/50-17	QV339	QV555	1042	A1042	1550Q	1142			
	245/50-17	QV339	QV555	1042	A1042	1553Q	1142			
17"	255/50-17	QV343	QV563	1042	A1042		1142			
	175/55-17	QV323	QV539							
	205/55-17	QV329	QV555							
	215/55-17	QV335	QV555	1038	A1038	1545Q	1138			
	225/55-17	QV339	QV555	1042	A1042	1550Q	1142			
	235/55-17	QV343	QV563	1042	A1042	1553Q	1142			
	245/55-17	QV339	QV563							
	255/55-17	QV343	QV563							
	275/55-17		QV575	1046	A1046		1146			
	205/60-17.5	QV335	QV555							
17"	215/60-17	QV339	QV563	1042	A1042	1553Q	1142			
	225/60-17	QV339	QV563	1042	A1042	1555Q	1142			
	235/60-17	QV343	QV563	1042	A1046		1146			

THIS IS A GUIDE ONLY — ACTUAL FITMENT MAY VARY / CLEARANCES VARY , PLEASE CHECK

PASSENGER

RIM SIZE	TIRE SIZE	VOLT QV300	HIGH VOLT QV500	COBRA CABLE 1000	LIGHTNING CABLE A1000	DIAMOND BACK 1500Q	TYPE "PL" 1100	CAR CHAIN 1200	V-BAR CHAIN 1800
		Pg.# 12	Pg.# 12	Pg.# 13	Pg.# 13	Pg.# 15	Pg.# 14	Pg.# 14	Pg.# 14
		Class (S)	Class (S)	Class (S)	Class (S)	Class (S)	Class (S)	Class (U)	Class (U)
17"	215/65-17	QV339	QV563	1042	A1042		1142		
	225/65-17	QV343	QV571	1042	A1042	1555Q	1142		
	235/65-17		QV571	1046	A1046	1555Q	1146	(ACURA MDX)	
	245/65-17		QV575	1046	A1046		1146		
	215/70-17	QUICKTRAK OR SPIKES-SPIDER RECOMMENDED SEE WEBSITE FOR FITMENTS							
	225/70-17			1046	A1046	1555Q	1146		
18"	205/75-17.5	QV343	QV575						
	285/30-18			1046	A1048		1146		
	295/30-18	QUICKTRAK OR SPIKES-SPIDER RECOMMENDED SEE WEBSITE FOR FITMENTS							
	215/35-18			1030	A1030		1130		
	255/35-18			1038	A1038		1138		
	265/35-18			1042	A1042		1142		
	275/35-18	QV343	QV555	1046	A1046		1146		
	285/35-18			1046	A1046		1146		
	295/35-18	QUICKTRAK OR SPIKES-SPIDER RECOMMENDED SEE WEBSITE FOR FITMENTS							
	215/40-18	QV327	QV547	1034	A1034	1547Q	1134		
	225/40-18		QV547	1034	A1034	1547Q	1134		
	235/40-18			1038	A1038		1138		
	245/40-18	QV339	QV555	1038	A1038		1138		
	255/40-18	QV343	QV555	1042	A1042		1142		
	265/40-18			1042	A1042	1553Q	1142		
	275/40-18			1046	A1046		1146		
	285/40-18	QV339	QV563						
	215/45-18	QV329	QV547	1038	A1038	1547Q	1138		
225/45-18		QV555	1038	A1038	1550Q	1138			
235/45-18	QV339	QV555	1042	A1042	1553Q	1142			
245/45-18		QV563	1042	A1042		1142			
255/45-18	QV343	QV563	1042	A1042		1142			
275/45-18		QV563	1046	A1046		1146			
225/50-18	QV339	QV555	1042	A1042	1553Q	1142			
235/50-18	QV343	QV563	1046	A1042	1553Q	1146			
245/50-18	QV343	QV563	1042	A1042		1146			
255/50-18	QV343	QV563							
215/55-18	QV339	QV571	1042	A1038	1553Q	1142			
225/55-18	QV339	QV563	1042	A1042	1553Q	1142			
235/55-18	QV343	QV563	1046	A1042		1146			
255/55-18		QV575	1046	A1046		1146			
285/55-18	QUICKTRAK OR SPIKES-SPIDER RECOMMENDED SEE WEBSITE FOR FITMENTS								
225/60-18		QV571	1046	A1046	1555Q	1146			
235/60-18		QV571	1046	A1046		1146			
225/65-18		QV575	1046	A1046		1146			
235/65-18		QV575	1046	A1048		1146			
19"	245/30-19	QUICKTRAK OR SPIKES-SPIDER RECOMMENDED SEE WEBSITE FOR FITMENTS							
	215/35-19			1034	A1034		1134		
	225/35-19			1038	A1038		1138		
	235/35-19			1038	A1038		1138		
	245/35-19			1042	A1042		1142		
	255/35-19			1042	A1042		1142		
	265/35-19	QV339							
	275/35-19		QV555	1046	A1046	1555Q	1146		
	285/35-19	QV339	QV563	1046	A1046		1146		
	235/40-19	QV339	QV555						

NEW VOLT PREMIUM PASSENGER

Volt cable chains give better traction than ladder style chains and longer wear using cross cables made of **ALLOY ROLLERS**. The diagonal cross cable design provides a smooth ride and easy installation.

SOLD WITH RUBBER ADJUSTER

(Packed 1 Pair Per Plastic Box, 2 Pair Per Master Carton)

FIND PRICING IN JOBBER ON WEBSITE
DO NOT USE ON TRAILERS



SAE Class "S"



STANDARD

STOCK NUMBER	WT. PER PAIR (lbs)	CROSS CHAIN	BUNGEE
QV311	7.7	QV1332	QV1170
QV315	8.3	QV1334	QV1172
QV319	9	QV1336	QV1172
QV323	9.1	QV1338	QV1172
QV327	9.1	QV1338	QV1172
QV329	10	QV1338	QV1172
QV331	10	QV1340	QV1172
QV335	10.1	QV1342	QV1172
QV339	10.8	QV1342	QV1174
QV343	11.1	QV1344	QV1174

NEW HIGH VOLT PREMIUM EMERGENCY VEHICLES

(Police, Fire, Ambulance)

High Volt cable chains were engineered to meet the high performance needs of Emergency Vehicles. Long lasting **ALLOY ROLLERS** and high strength aircraft cable provide maximum traction and durability. Easy installation with no rubber adjusters needed.

(Packed 1 Pair Per Plastic Box, 2 Pair Per Master Carton)

FIND PRICING IN JOBBER ON WEBSITE
DO NOT USE ON TRAILERS



SAE Class "S"



STANDARD

STOCK NUMBER	WT. PER PAIR (lbs)	CROSS CHAIN
QV539	10.75	QV9380
QV547	11.5	QV9384
QV555	12	QV9388
QV563	12	QV9388
QV571	12.25	QV9390
QV575	12.25	QV9394
QV579	12.5	QV9394
QV583	13	QV9398

PASSENGER

SAE Class "S"

COBRA™ CABLE CHAIN

Tough carbon steel rollers provide traction and long wear. The low profile steel rollers allow increased tire-to-road contact, resulting in better stability, plus a considerable reduction in noise and vibration. Totally galvanized for rust prevention.

These chains are designed for use on autos having minimal clearance availability, using original equipment tires with highway tread.

(Packed 1 Pair Per Box, 4 Pair Per Master Carton)

(Also available in bags, 4 Pair Per Master Carton)

DO NOT USE CABLE CHAINS ON SNOW TIRES OR TRAILERS.

FIND PRICING IN JOBBER ON WEBSITE

SAE CLASS (S) CLEARANCE

FIND FIT CHART ON PAGES 5-11

REGULAR							
Stock No.	Wt./Pr.	Cross Chain Length	Overall Length	Stock No.	Wt./Pr.	Cross Chain Length	Overall Length
1014	5	10.4"	56.8"	1034	6	12.8"	66.8"
1018	6	10.4"	61.8"	1038	7	12.8"	71.8"
1022	6	10.4"	66.8"	1042	8	14.0"	71.8"
1026	5	11.6"	61.8"	1046	8	14.0"	76.0"
1030	6	11.6"	66.8"				



STANDARD



OPTIONAL



PART # 0212

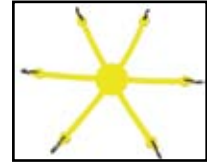

Optional
SPIDER BUNGEE
Sold Separately

SAE Class "S"

PASSENGER

LIGHTNING CABLE **FIND FIT CHART ON PAGES 5-11**

0238
0213

DIAGONAL CROSS CABLE DESIGN

PROVIDES SMOOTH RIDE AND EASY INSTALLATION

SAE CLASS (S) CLEARANCE

SOLD WITH RUBBER ADJUSTER

(Packed 1 Pair Per Bag, 4 Pair Per Master Carton)

DO NOT USE ON TRAILERS

FIND PRICING IN JOBBER ON WEBSITE

Stock No.	Wt./Pr.	Cross Chain No.	Cross Chain Length
A1014	6	8830	11"
A1018	7	8831	12"
A1022	8	8832	13"
A1026	8	8833	13.75"
A1030	9	8834	14.75"

Stock No.	Wt./Pr.	Cross Chain No.	Cross Chain Length
A1034	9	8834	14.75"
A1038	10	8835	15.75"
A1042	10	8836	16.25"
A1046	11	8837	17"
A1048	11	8838	18"

SPIDER BUNGEE



PASSENGER 7 ARM

PART # 0213

**For Use With
A1000 Series
Cable Chain**

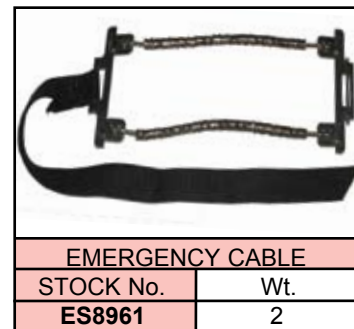

EMERGENCY CABLE

STOCK No.	Wt.
ES8961	2

NOT SAE CLASS "S" CLEARANCE

Fits all Passenger Sizes



PASSENGER

SAE Class "S"

"PL" 1100 SERIES LINK CHAIN

These chains are designed for use on cars having minimal clearance availability, using original equipment size tires with highway tread.

DO NOT USE TYPE "PL" CHAINS ON SNOW TIRES OR TRAILERS.

SAE CLASS (S) CLEARANCE

(Packed 1 Pair Per Box, 4 Pair Per Master Carton)

FIND FIT CHART ON PAGES 5-11



1100 ALL LINK

FIND PRICING IN JOBBER ON WEBSITE

Stock No.	Wt./Pr.	Cross Chain No.
1110	8	5414
1114	9	5414
1118	9	5414
1122	10	5414
1126	10	5419

Stock No.	Wt./Pr.	Cross Chain No.
1130	11	5419
1134	11	5420
1138	12	5420
1142	13	5422
1146	14	5422



STANDARD PACKAGE

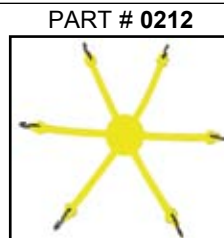

Optional SPIDER BUNGEE
Sold Separately

PASSENGER

CAR CHAINS FIND FIT CHART ON PAGES 5-11

REGULAR HIGHWAY SERVICE (TYPE P)
V-BAR REINFORCED (TYPE RP)

WARNING: Check owner's manual to determine if SAE CLASS "S" chains are required. 1979 or newer automobiles may have limited clearances

(Packed 1 Pair Per Box, 4 Pair Per Master Carton)

FIND PRICING IN JOBBER ON WEBSITE

REGULAR (TYPE P)			REGULAR (TYPE P)		
Stock No.	Wt./Pr.	Cross Chain No.	Stock No.	Wt./Pr.	Cross Chain No.
1206	12	5214	1230	15	5220
1210	17	5214	1240	16	5220
1217	15	5214	1250	19	5222
			1254	18	5222



Regular (Type P)



V-Bar (Type RP)

V-BAR (TYPE RP)			V-BAR (TYPE RP)		
Stock No.	Wt./Pr.	Cross Chain No.	Stock No.	Wt./Pr.	Cross Chain No.
1806	13	5814	1830	17	5820
1810	15	5814	1840	19	5820
			1850	21	5822
1817	14	5814	1854	19	5822



STANDARD PACKAGE



STANDARD PACKAGE

PASSENGER

DIAMOND BACK SQUARE LINK

The Diamond Back is a premium European design tire chain. Square link construction with a diamond pattern for excellent traction, smooth ride and long wear.

SAE CLASS (S) CLEARANCE

FIND PRICING IN JOBBER ON WEBSITE

FIND FIT CHART ON PAGES 5-11

DO NOT USE ON TRAILERS

(Packed 1 Pair Per Bag, 4 Pair Per Master Carton)



STANDARD PACKAGE



INSIDE FASTENER



SAE Class "S"

3.7 MM

Stock No.	Wt./ Pr .	Cross Chain No.
1505Q	8	1572
1510Q	8	1574
1515Q	9	1576
1520Q	9	1576
1525Q	9	1578
1530Q	10	1582

Stock No.	Wt./ Pr .	Cross Chain No.
1535Q	10	1584
1540Q	10	1588
1545Q	11	1588
1547Q	12	1592
1550Q	13	1594
1553Q	13	1596
1555Q	13	1596

PARTS AND PIECES

Stock No.	Application	Std Pkg.	Wt./Pkg.
F-3	1500Q & 2300LW / 2500Q series Quick Hook	10	.15



L-3	1500Q & 2300LW / 2500Q series Lock System	10	.20
-----	---	----	-----



R-1	1500Q & 2300LW series Rubber End	10	.25
R-2	2500Q series Rubber End	10	.25



PK-1	1500Q & 2300LW series 4 pc Repair Kit	10	.22
PK-2	2500Q series 4 pc Repair Kit	10	.22



S-1	1500Q & 2300LW / 2500Q series Shortening Hook	10	.06
-----	---	----	-----



THIS IS A GUIDE ONLY — ACTUAL FITMENT MAY VARY

LIGHT TRUCK / SUV

Tire Size	Volt LT Cable	High Volt Cable	Cobra Cable	Lightning Cable	Diamond Back	Light Weight Diamond	Regular Single	V-Bar Single	Square Link Single	Regular Wide Base	V-Bar Wide Base	Square Link Wide Base	Mud Service
	QV700	QV500	1600	A2000	2500Q	2300LW	2200	2800	2100SLC	3200	3800	3100SLC	2400HH
	Pg.# 22	Pg.# 22	Pg.# 23	Pg.# 23	Pg.# 25	Pg.# 24	Pg.# 26	Pg.# 26	Pg.# 28	Pg.# 27	Pg.# 27	Pg.# 27	Pg.# 28
7.50-16			1669	A2019	2519Q	2319LW	2221	2821	2121SLC				2437HH
8.75-16.5	QV729	QV575											
9.50-16.5	QV735	QV579	1669	A2019	2519Q	2319LW	2221	2821	2121SLC				2437HH
10-16.5			1669							3210	3810	3110SLC	2435HH
12-16.5			1675	A2027	2527Q	2327LW				3229	3829	3129SLC	2441HH
225/60-14		QV547			2519Q	2319LW	2209	2809	2109SLC				
195/75-14			1030		1535Q		2209	2809	2109SLC				
215/75-14		QV555	1661		1545Q		2216	2816	2116SLC				
305/50-15							2216	2816	2116SLC				
275/60-15			1661	A2019	2519Q	2319LW	2229	2829	2129SLC				2437HH
325/60-15	QV747				2519Q	2319LW				3229	3829	3129SLC	
255/65-15		QV563	1661	A2029	2529Q	2329LW	2229	2829	2129SLC				2437HH
355/65-15					2514Q	2314LW				3259	3859	3159SLC	
225/70-15		QV563	1661	A2015	2515Q	2315LW	2216	2816	2116SLC				
235/70-15		QV563	1661	A2017	2517Q	2317LW	2216	2816	2116SLC				
245/70-15	QV729	QV563	1661	A2017	2519Q	2319LW	2229	2829	2129SLC				2437HH
255/70-15			1661	A2019	2519Q	2319LW	2229	2829	2129SLC				2437HH
265/70-15	QV735	QV575	1665	A2019	2519Q	2319LW	2221	2821	2121SLC				2437HH
265/790-540A	QV735	QV579											
285/70-15	QV747	QV579	1661		2529Q	2329LW	2219	2819	2119SLC				
295/70-15	QV751	QV579											
310/70-15		QV583											
215/75-15		QV571	1661	A2015	2515Q	2315LW	2216	2816	2116SLC				2433HH
225/75-15		QV563	1661	A2015	2515Q	2315LW	2216	2816	2116SLC				2435HH
235/75-15	QV729	QV571	1661	A2017	2517Q	2317LW	2219	2819	2119SLC				2435HH
245/75-15			1669	A2021	2521Q	2321LW	2221	2821	2121SLC				2437HH
255/75-15			1669	A2027	2527Q	2327LW	2228	2828	2128SLC				2439HH
265/75-15	QV741	QV575	1669	A2019	2519Q	2319LW	2221	2821	2121SLC				2437HH
275/75-15	QV747	QV575											
285/75-15	QV747	QV579											
305/75-15					2519Q	2319LW				3229	3829	3129SLC	
245/85-15	QV735	QV579	1669	A2029	2529Q	2329LW	2228	2828	2128SLC				2441HH
225/50-16		QV547					2209	2809	2109SLC				
265/55-16			1661		2521Q	2321LW	2229	2829	2129SLC				
275/55-16			1665	A2019	2519Q	2319LW	2229	2829	2129SLC				
235/60-16		QV563					2211	2811	2111SLC				
255/60-16		QV555	1665				2229	2829	2129SLC				
265/60-16	QV729	QV571											
275/60-16	QV741	QV575											
285/60-16	QV735	QV579	1673				2228	2828	2128SLC	3227	3827	3127SLC	2439HH
235/65-16		QV563	1665	A1042	1555Q		2227	2827	2127SLC				
245/65-16	QV729	QV563											
255/65-16	QV735	QV571	1669	A2019	2519Q	2319LW	2229	2829	2129SLC	3210	3810	3110SLC	2437HH
265/65-16	QV735	QV575	1661	A2019	2519Q	2319LW	2229	2829	2129SLC				2437HH
275/65-16	QV741	QV579	1673		2521Q	2321LW	2228	2828	2128SLC				
285/65-16	QV741	QV579											
295/65-16	QV741	QV579	1675	A2014	2514Q	2314LW				3229	3829	3129SLC	
365/65-16					2539Q								
215/70-16		QV563	1661	A2015	2515Q	2315LW	2216	2816	2116SLC				
225/70-16		QV571	1661	A2017	2517Q	2317LW	2219	2819	2119SLC				2435HH
235/70-16	QV729	QV571	1665	A2019	2519Q	2319LW	2229	2829	2129SLC				
245/70-16	QV735	QV575	1669	A2019	2519Q	2319LW	2229	2829	2129SLC				
255/70-16	QV735	QV575	1669	A2019	2519Q	2319LW	2221	2821	2121SLC				2437HH
265/70-16	QV741	QV579	1663	A2029	2529Q	2329LW	2228	2828	2128SLC				2439HH
275/70-16	QV747	QV579	1675	A2021	2521Q	2321LW				3228	3828	3128SLC	
285/70-16			1675							3229	3829	3129SLC	
305/70-16		QV583		A2027	2536Q	2335LW	2238	2838	2138SLC				2440HH
315/70-16	QV751									3231	3831	3131SLC	
205/75-16		QV555	1661				2216	2816	2116SLC				2433HH
215/75-16	QV729	QV571	1669	A2015	2515Q	2315LW	2216	2816	2116SLC				

THIS IS A GUIDE ONLY. ACTUAL FITMENT MAY VARY AND CLEARANCES

VARY, PLEASE CHECK

CAM STYLE AVAILABLE ON MOST APPLICATIONS ADD (QC)



THIS IS A GUIDE ONLY — ACTUAL FITMENT MAY VARY

Tire Size	Volt LT Cable	High Volt Cable	Cobra Cable	Lightning Cable	Diamond Back	Light Weight Diamond	Regular Single	V-Bar Single	Square Link Single	Regular Wide Base	V-Bar Wide Base	Square Link Wide Base	Mud Service
	QV700	QV500	1600	A2000	2500Q	2300LW	2200	2800	2100SLC	3200	3800	3100SLC	2400HH
	Pg.# 22	Pg.# 22	Pg.# 23	Pg.# 23	Pg.# 25	Pg.# 24	Pg.# 26	Pg.# 26	Pg.# 28	Pg.# 27	Pg.# 27	Pg.# 27	Pg.# 28
225/75-16	QV729	QV571	1665	A2017	2517Q	2317LW	2219	2819	2119SLC				2435HH
235/75-16	QV735	QV575	1665	A2019	2519Q	2319LW	2219	2819	2119SLC				2435HH
245/75-16	QV741	QV575	1669	A2029	2529Q	2329LW	2221	2821	2121SLC				2437HH
255/75-16	QV747	QV575		A2029	2521Q	2321LW	2228	2828	2128SLC				2439HH
265/75-16	QV751	QV579	1675	A2021	2521Q	2321LW	2228	2828	2128SLC				2439HH
275/75-16	QV747	QV579											
285/75-16	QV751		1675	A2014	2514Q	2314LW	2238	2838	2138SLC	3229	3829	3129SLC	2440HH
295/75-16			1678		2521Q	2321LW				3231	3831	3131SLC	2441HH
315/75-16			2314		2536Q	2337LW				3231	3831	3131SLC	2441HH
205/80-16			1661				2229	2829	2129SLC				
215/80-16	QV729	QV575											
235/80-16			1669	A2017	2519Q	2319LW	2219	2819	2119SLC				
265/80-16	QV747	QV583											
325/80-16										3251	3851	3151SLC	
215/85-16	QV729	QV575	1665	A2019	2519Q	2319LW	2219	2819	2119SLC				2435HH
225/85-16	QV735	QV575	1669		2517Q	2317LW	2221	2821	2121SLC				2437HH
235/85-16	QV741	QV579	1669	A2021	2521Q	2321LW	2221	2821	2121SLC				2437HH
245/85-16	QV747	QV579	1663				2228	2828	2128SLC				2439HH
255/85-16		QV583	1675	A2014	2514Q	2314LW	2228	2828	2128SLC				2439HH
265/85-16		QV583	1675		2519Q	2319LW	2228	2828	2128SLC				2439HH
275/85-16			1675				2238	2838	2138SLC	3228	3828	3128SLC	
305/85-16					2527Q	2327LW				3259	3859	3159SLC	
245/45-17		QV555	1042	A1042			1138						
235/50-17		QV555	1042	A1042	1550Q		1142						
275/50-17			1669	A2019	2519Q	2319LW	2227	2827	2127SLC				
235/55-17		QV563	1661										
255/55-17		QV563	1665	A2019	2517Q	2317LW	2219	2819	2119SLC				
265/55-17	QV735	QV575	1669	A2019	2519Q	2319LW	2227	2827	2127SLC				
275/55-17	QV741	QV575	1673	A2029	2519Q	2319LW	2227	2827	2127SLC				
345/55-17	QV751	QV583											
235/60-17		QV563	1665				2227	2827	2127SLC				
245/60-17	QV729	QV563	1665	A2017	2517Q	2317LW	2229	2829	2129SLC				
255/60-17	QV735	QV571	1673	A2029	2519Q	2319LW	2227	2827	2127SLC	3210	3810	3110SLC	
265/60-17	QV735	QV575	1673	A2021	2519Q	2319LW	2227	2827	2127SLC				
275/60-17	QV741	QV579	1675	A2021	2529Q	2329LW	2228	2828	2128SLC	3227	3827	3127SLC	
285/60-17	QV747	QV579	1675	A2027	2527Q	2327LW	2228	2828	2128SLC				2439HH
305/60-17										3235	3835	3135SLC	
235/65-17	QV729	QV571	1665	A2019	2519Q	2319LW	2211	2811	2111SLC				
245/65-17	QV735	QV575	1669	A2019	2519Q	2319LW	2227	2827	2127SLC				2439HH
255/65-17	QV735	QV575	1663	A2019	2519Q	2319LW	2227	2827	2127SLC				2439HH
265/65-17	QV741	QV579	1663	A2021	2521Q	2321LW	2227	2827	2127SLC				2439HH
275/65-17	QV747	QV579											
285/65-17	QV747	QV579											
305/65-17	QV751		1680	A2019	2536Q	2335LW				3229	3829	3129SLC	
225/70-17	QV729	QV575	1665		2517Q	2317LW	2219	2819	2119SLC				
235/70-17	QV735	QV579	1665	A2019	2519Q	2319LW	2219	2819	2119SLC				
245/70-17	QV735	QV575	1673	A2029	2521Q	2321LW	2227	2827	2127SLC				
255/70-17	QV747	QV579	1663	A2021	2521Q	2321LW	2229	2829	2129SLC				2440HH
265/70-17	QV751	QV579	1675	A2021	2521Q	2321LW	2229	2829	2129SLC				2439HH
275/70-17	QV747	QV579	1675	A2021	2521Q	2321LW	2228	2828	2128SLC	3227	3827	3127SLC	2439HH
285/70-17		QV583	1678		2533Q	2328LW	2238	2838	2138SLC	3228	3828	3128SLC	2440HH
295/70-17			1678		2536Q					3229	3829	3129SLC	
305/70-17			1678		2536Q					3229	3829	3129SLC	
315/70-17			1681	A2014	2536Q					3231	3831	3131SLC	
225/75-17	QV729	QV575	1669	A2029	2519Q	2319LW	2219	2819	2119SLC				
235/75-17	QV735	QV579	1675	A2021	2521Q	2321LW	2227	2827	2127SLC				
245/75-17	QV741	QV579	1675	A2021	2521Q	2321LW	2228	2828	2128SLC				2439HH
255/75-17	QV751	QV579	1663	A2021	2527Q	2327LW	2228	2828	2128SLC				2439HH
265/75-17	QV751	QV583		A2021	2521Q	2321LW	2228	2828	2128SLC				
285/75-17		QV583	1680	A2027						3229	3829	3129SLC	

CAM STYLE AVAILABLE ON MOST APPLICATIONS ADD (QC)



LIGHT TRUCK / SUV

THIS IS A GUIDE ONLY — ACTUAL FITMENT MAY VARY

Tire Size	Volt LT Cable	High Volt Cable	Cobra Cable	Lightning Cable	Diamond Back	Light Weight Diamond	Regular Single	V-Bar Single	Square Link Single	Regular Wide Base	V-Bar Wide Base	Square Link Wide Base	Mud Service
	QV700	QV500	1600	A2000	2500Q	2300LW	2200	2800	2100SLC	3200	3800	3100SLC	2400HH
	Pg.# 22	Pg.# 22	Pg.# 23	Pg.# 23	Pg.# 25	Pg.# 24	Pg.# 26	Pg.# 26	Pg.# 28	Pg.# 27	Pg.# 27	Pg.# 27	Pg.# 28
215/80-17	QV735	QV575											
225/80-17	QV741												
235/80-17	QV747	QV579	1669				2221	2821	2121SLC				
275/80-17			1680							3231	3831	3131SLC	
235/85-17	QV741	QV579											
245/85-17			1675	A2014			2228	2828	2128SLC				
7-17.5	QV343	QV571											
215/70-17.5			1673	A2015	2515Q	2315LW	2219	2819	2119SLC				2435HH
225/70-17.5			1663	A2017	2517Q	2317LW	2214	2814	2114SLC				2439HH
235/70-17.5	QV735												
245/70-17.5	QV741		1675	A2021	2521Q	2321LW	2228	2828	2128SLC				
275/70-17.5					2519Q	2319LW	2238	2838	2138SLC	3228	3828	3128SLC	2440HH
205/75-17.5	QV729	QV575	1661	A2029	2529Q	2329LW							
215/75-17.5	QV729	QV575	1673	A2019	2519Q	2319LW	2229	2829	2129SLC				2437HH
225/75-17.5	QV735		1665	A2021	2521Q	2321LW							
235/75-17.5	QV741	QV579	1665	A2014	2514Q	2314LW	2228	2828	2128SLC				2439HH
245/75-17.5	QV741												
295/45-18			1673	A2021			2227	2827	2127SLC				
285/50-18	QV735	QV575	1675	A2021	2529Q	2329LW	2228	2828	2128SLC	3227	3827	3127SLC	2439HH
225/55-18		QV563					2229	2829	2129SLC				
235/55-18		QV563	1673				2229	2829	2129SLC				
245/55-18	QV729	QV563	1673				2229	2829	2129SLC				
255/55-18	QV735	QV575	1673	A2021	2519Q	2319LW	2229	2829	2129SLC				2435HH
265/55-18	QV735	QV575											
275/55-18	QV741	QV579	1675	A2029	2521Q	2321LW	2227	2827	2127SLC	3227	3827	3127SLC	
285/55-18	QV741		1679	A2027	2527Q	2327LW	2227	2827	2127SLC	3227	3827	3127SLC	
305/55-18	QV747												
225/60-18	QV729	QV571											
235/60-18	QV729	QV571	1669	A2017	2517Q	2317LW	2229	2829	2129SLC				2439HH
245/60-18	QV735	QV575	1673	A2019	2519Q	2319LW	2229	2829	2129SLC				2439HH
255/60-18	QV741	QV579	1675	A2021	2521Q	2321LW	2227	2827	2127SLC				
265/60-18	QV741	QV579	1675	A2021	2521Q	2321LW	2228	2828	2128SLC				
275/60-18	QV747	QV579	1675		2529Q	2329LW	2228	2828	2128SLC				2439HH
285/60-18	QV751	QV579	1675	A2027	2527Q	2327LW	2228	2828	2128SLC				2439HH
295/60-18	QV747	QV579											
305/60-18			1681		2536Q					3231	3831	3131SLC	
325/60-18					2536Q					3231	3831	3131SLC	
225/65-18	QV735	QV575	1673	A2019	2519Q	2319LW	2229	2829	2129SLC				
235/65-18	QV735	QV575	1673	A2019	2519Q	2319LW	2229	2829	2129SLC				2439HH
255/65-18	QV747	QV579	1675	A2029	2521Q	2321LW	2227	2827	2127SLC				2439HH
265/65-18	QV747	QV579	1663	A2014	2527Q	2327LW				3228	3828	3128SLC	2439HH
275/65-18	QV751	QV579	1675	A2027	2533Q		2228	2828	2128SLC	3228	3828	3128SLC	2439HH
285/65-18		QV583	1678				2228	2828	2128SLC	3235	3835	3135SLC	2439HH
295/65-18										3235	3835	3135SLC	
305/65-18			1681							3231	3831	3131SLC	
325/65-18			1681							3235	3835	3135SLC	
355/65-18										3254	3854	3154SLC	
225/70-18	QV735	QV579	1663										
235/70-18	QV741	QV579											
255/70-18	QV747	QV579	1663		2527Q	2327LW	2228	2828	2128SLC				2439HH
265/70-18	QV751	QV583	1678	A2027			2228	2828	2128SLC				2439HH
275/70-18		QV583	1680	A2027	2533Q					3228	3828	3128SLC	
285/70-18		QV583	1681							3231	3831	3131SLC	
305/70-18			2314		2539Q					3231	3831	3131SLC	
245/75-18	QV751												
265/75-18		QV583	1679							3229	3829	3129SLC	
275/75-18			1679							3229	3829	3129SLC	
285/75-18										3231	3831	3131SLC	

CAM STYLE AVAILABLE ON MOST APPLICATIONS ADD (QC)



LIGHT TRUCK / SUV

THIS IS A GUIDE ONLY — ACTUAL FITMENT MAY VARY

Tire Size	Volt LT Cable	High Volt Cable	Cobra Cable	Lightning Cable	Diamond Back	Light Weight Diamond	Regular Single	V-Bar Single	Square Link Single	Regular Wide Base	V-Bar Wide Base	Square Link Wide Base	Mud Service
	QV700	QV500	1600	A2000	2500Q	2300LW	2200	2800	2100SLC	3200	3800	3100SLC	2400HH
	Pg.# 22	Pg.# 22	Pg.# 23	Pg.# 23	Pg.# 25	Pg.# 24	Pg.# 26	Pg.# 26	Pg.# 28	Pg.# 27	Pg.# 27	Pg.# 27	Pg.# 28
235/80-18			1675	A2021	2521Q	2321LW	2228	2828	2128SLC				2439HH
275/45-19			1673	A2029	2519Q	2319LW	2229	2829	2129SLC				
285/45-19	QV735	QV575	1663	A2029	2529Q	2329LW	2227	2827	2127SLC				
245/50-19	QV729	QV571											
255/50-19	QV735	QV571	1669	A2029	2529Q	2329LW	2227	2827	2127SLC				
265/50-19	QV735	QV575											
275/50-19	QV735	QV579					2219	2819	2119SLC				
235/55-19	QV729	QV575					2227	2827	2127SLC				
245/55-19	QV735	QV575	1669		2519Q	2319LW	2227	2827	2127SLC				
255/55-19	QV735	QV579	1663		2521Q	2321LW	2227	2827	2127SLC				
275/55-19	QV747	QV579		A2014	2514Q	2314LW	2228	2828	2128SLC				
225/60-19	QV735	QV575											
255/60-19	QV747	QV579	1663				2228	2828	2128SLC				
285/60-19		QV583											
255/65-19	QV747	QV579											
225/70-19.5	QV747		1663	A2021	2521Q	2321LW	2214	2814	2114SLC				2437HH
235/70-19.5	QV741												
245/70-19.5	QV751	QV583	1675	A2014	2514Q	2314LW	2228	2828	2128SLC				2439HH
265/70-19.5			1680		2529Q	2329LW	2237	2837	2137SLC				
285/70-19.5			2315		2527Q	2327LW	2246	2846	2146SLC				
305/70-19.5					2514Q	2314LW	2239	2839	2139SLC				
215/75-19.5	QV747	QV579											
225/75-19.5	QV747												
305/30-20										3257	3857	3157SLC	
275/40-20			1663	A2021	2521Q	2321LW	2227	2827	2127SLC				
285/40-20	QV741	QV579											
295/40-20	QV735	QV579	1675	A2021			2228	2828	2128SLC				2439HH
235/45-20			1665										
245/45-20	QV729	QV575	1669	A2019	2519Q	2319LW	2229	2829	2129SLC				
255/45-20	QV729	QV575	1669	A2021	2519Q	2319LW	2229	2829	2129SLC				
265/45-20	QV735	QV575	1673	A2021	2519Q	2319LW	2227	2827	2127SLC				
275/45-20	QV741	QV579	1675	A2021	2521Q	2321LW	2228	2828	2128SLC	3227	3827	3127SLC	2439HH
295/45-20			1679				2228	2828	2128SLC	3227	3827	3127SLC	2439HH
305/45-20			1679							3229	3829	3129SLC	
245/50-20	QV735	QV575	1669	A2029	2521Q	2321LW	2227	2827	2127SLC				
255/50-20	QV735	QV579	1675		2521Q	2321LW	2227	2827	2127SLC	3227	3827	3127SLC	
265/50-20	QV747	QV579	1675	A2021	2527Q	2327LW				3227	3827	3127SLC	
275/50-20	QV747	QV579	1679				2228	2828	2128SLC				
285/50-20	QV751	QV579	1679	A2027		2328LW				3228	3828	3128SLC	
295/50-20	QV751	QV579	1680	A2027						3228	3828	3128SLC	
305/50-20		QV583	1681			2328LW	2238	2838	2138SLC	3229	3829	3129SLC	2440HH
325/50-20			2314							3231	3831	3131SLC	
225/55-20	QV735	QV575											
255/55-20	QV747	QV579											
275/55-20	QV751	QV583	1679	A2014	2533Q	2328LW	2238	2838	2138SLC	3228	3828	3128SLC	
285/55-20	QV751	QV583											
305/55-20	QV853				2536Q					3231	3831	3131SLC	
245/60-20	QV741	QV579											
255/60-20			1679				2228	2828	2128SLC				
265/60-20	QV751	QV579											
275/60-20	QV751	QV583	1679	A2014	2533Q		2238	2838	2138SLC				2440HH
285/60-20			1679	A2027			2238	2838	2138SLC				
325/60-20			2314		2539Q					3235	3835	3135SLC	
355/60-20										3251	2851	3151SLC	
265/65-20		QV583											
275/65-20		QV583	1681		2536Q					3231	3831	3131SLC	
285/65-20			1681							3231	3831	3131SLC	
395/65-20										3236	3836	3136SLC	

CAM STYLE AVAILABLE ON MOST APPLICATIONS ADD (QC)

WWW.QUALITYCHAINCORP.COM



LIGHT TRUCK TIRE CHAIN FIT CHART

THIS IS A GUIDE ONLY — ACTUAL FITMENT MAY VARY

LIGHT TRUCK / SUV

Tire Size	Volt LT Cable	High Volt Cable	Cobra Cable	Lightning Cable	Diamond Back	Light Weight Diamond	Regular Single	V-Bar Single	Square Link Single	Regular Wide Base	V-Bar Wide Base	Square Link Wide Base	Mud Service
	QV700	QV500	1600	A2000	2500Q	2300LW	2200	2800	2100SLC	3200	3800	3100SLC	2400HH
	Pg.# 22	Pg.# 22	Pg.# 23	Pg.# 23	Pg.# 25	Pg.# 24	Pg.# 26	Pg.# 26	Pg.# 28	Pg.# 27	Pg.# 26	Pg.# 27	Pg.# 28
225/75-20	QV747												
285/45-21	QV741	QV583											
255/50-21	QV747	QV579											
295/30-22			1675	A2014									
265/35-22			1673	A2021									
285/35-22			1675	A2014	2527Q	2327LW	2228	2828	2128SLC				
265/40-22			1663	A2021	2521Q	2321LW	2227	2827	2127SLC				
305/40-22			1681	A2027	2527Q	2327LW	2238	2838	2138SLC	3228	3828	3128SLC	
325/40-22			1681			2328LW	2238	2838	2138SLC				
275/45-22	QV747	QV579	1679	A2014	2514Q	2314LW							
285/45-22	QV751	QV583	1679	A2014	2533Q	2328LW	2238	2838	2138SLC				
305/45-22			1680				2238	2838	2138SLC				
325/50-22			2315		2539Q					3235	3835	3135SLC	
305/60-22			QUICKTRAK OR SPIKE-SPIDER RECOMMENDED SEE WEBSITE FOR FITMENTS										
295/35-24			1681										
305/35-24			1681										
285/40-24			1680	A2027						3229	3829	3129SLC	
295/40-24			1681		2536Q	2337LW				3231	3831	3131SLC	
305/30-26			1681										
27X8.50-14			1661		1545Q		2216	2816	2116SLC	3237	3837	3137SLC	
27X9.50-14			1665				2216	2816	2116SLC				
29X9.50-14			1665				2216	2816	2116SLC	3237	3837	3137SLC	
14X36.5-15			3065							3255	3855	3155SLC	
27X9.50-15			1661				2229	2829	2129SLC				
28X8.50-15			1661				2211	2811	2111SLC				
29X9.50-15			1661				2229	2829	2129SLC	3210	3810	3110SLC	2437HH
30X9.50-15	QV735	QV575	1673	A2019	2519Q	2319LW	2229	2829	2129SLC	3210	3810	3110SLC	2437HH
31X9.50-15			1673	A2019	2519Q	2319LW				3227	3827	3127SLC	2437HH
31X10.50-15	QV741	QV579	1669	A2019	2519Q	2319LW				3227	3827	3127SLC	
31X11.50-15	QV747		1669	A2029	2529Q	2329LW				3227	3827	3127SLC	
31X12.50-15			1675	A2014	2514Q	2314LW				3229	3829	3129SLC	
32X9.50-15			1669	A2019	2519Q	2319LW				3227	3827	3127SLC	
32X11.50-15			1675	A2014	2514Q	2314LW				3229	3829	3129SLC	
32X12.50-15			1675	A2014	2514Q	2314LW				3229	3829	3129SLC	
33X9.50-15			1675	A2014	2514Q	2314LW	2227	2827	2127SLC	3227	3827	3127SLC	
33X10.50-15			1675	A2014	2514Q	2314LW				3229	3829	3129SLC	
33X12.50-15			1675	A2014	2514Q	2314LW				3229	3829	3129SLC	
33X14.50-15					2337LW					3231	3831	3131SLC	
35X10.50-15			1679	A2014	2514Q	2314LW	2228	2828	2128SLC	3227	3827	3127SLC	
35X12.50-15			1681		2536Q					3235	3835	3135SLC	
35X13.50-15					2533Q					3235	3835	3135SLC	
35X14-15										3235	3835	3135SLC	
35X14.50-15						2337LW				3235	3835	3135SLC	
36X12.50-15										3235	3835	3135SLC	
36X13.50-15										3265	3865	3165SLC	
36X14-15										3251	3851	3151SLC	
36X14.50-15										3251	3851	3151SLC	
37X12.50-15										3235	3835	3135SLC	2445HH
37X14.50-15										3251	3851	3151SLC	
38X12.50-15										3259	3859	3159SLC	
38X14.50-15										3259	3859	3159SLC	
38X15-15										3235	3835	3135SLC	
38X15.50-15										3249	3849	3149SLC	
38.5X16-15										3249	3849	3149SLC	
39X13.50-15										3254	3854	3154SLC	
40X17-15										3251	3851	3151SLC	
42X15-15										3267	3867	3167SLC	
44X18.50-15										3269	3869	3169SLC	

THIS IS A GUIDE ONLY.

ACTUAL FITMENT MAY VARY.

VARY AND CLEANANCES

VARY, PLEASE CHECK

**WE CAN
CUSTOM BUILD
MOST CHAINS
IF A SIZE OR PART #
IS NOT LISTED**

CAM STYLE AVAILABLE ON MOST APPLICATIONS ADD (QC)

WWW.QUALITYCHAINCORP.COM

NEW VOLT LT

PREMIUM LIGHT TRUCK / SUV

Volt LT cable chains are built for larger tires on Light Trucks & SUV's. They also give better traction than ladder style chains and longer wear using cross cables made of **ALLOY ROLLERS**. The diagonal cross cable design provides a smooth ride and easy installation.

SOLD WITH RUBBER ADJUSTER

(Packed 1 Pair Per Plastic Box, 2 Pair Per Master Carton)
DO NOT USE ON TRAILERS

[FIND PRICING IN JOBBER ON WEBSITE](#)

STOCK NUMBER	WT. PER PAIR (lbs)	CROSS CHAIN	BUNGEE
QV729	13.25	QV1742	QV1174
QV735	13.5	QV1742	QV1176
QV741	14	QV1744	QV1176
QV747	14.75	QV1746	QV1176
QV751	14.5	QV1746	QV1176
QV753	15.65	QV1748	QV1178
QV757	16.75	QV1748	QV1178
QV761	18.5	QV1750	QV1180



SAE Class "S"



STANDARD

NEW HIGH VOLT

PREMIUM EMERGENCY VEHICLES

(Police, Fire, Ambulance)

High Volt cable chains were engineered to meet the high performance needs of Emergency Vehicles. Long lasting **ALLOY ROLLERS** and high strength aircraft cable provide maximum traction and durability. Easy installation with no rubber adjusters needed.

(Packed 1 Pair Per Plastic Box, 2 Pair Per Master Carton)

[FIND PRICING IN JOBBER ON WEBSITE](#)
DO NOT USE ON TRAILERS

STOCK NUMBER	WT. PER PAIR (lbs)	CROSS CHAIN
QV539	10.75	QV9380
QV547	11.5	QV9384
QV555	12	QV9388
QV563	12	QV9388
QV571	12.25	QV9390
QV575	12.25	QV9394
QV579	12.5	QV9394
QV583	13	QV9398



SAE Class "S"



STANDARD

COBRA™ CABLE CHAINS

LIGHT TRUCK, RV, SUV, VAN COBRA JR'S

SAE CLASS "S"

Tough carbon steel rollers provide traction and long wear. The low profile steel rollers allow increased tire-to-road contact, resulting in better stability, plus a considerable reduction in noise and vibration. Totally galvanized for rust prevention. These chains are designed for use on autos having minimal clearance availability, using original equipment tires with highway tread.

(Packed 1 Pair Per Box or 1 Pair Per Bag)

DO NOT USE ON TRAILERS

FIND PRICING IN JOBBER ON WEBSITE



STANDARD

OPTIONAL

Stock No.	Wt./Pr.	Cross Chain No.	Cross Chain Length	Overall Length
1661	10	8818	13.5"	75"
1663	12	8820	14.5"	85"
1665	11	8820	14.5"	74.5"
1669	12	8820	14.5"	80"
1673	11	8822	15.5"	75"
1675	13	8822	15.5"	85"
1678	14	8822	15.5"	90.5"
1679	15	8823	16.25"	85"
1680	15	8824	17.5"	85"
1681	15	8826	17"	90"

PART # 0216

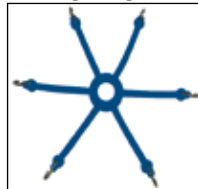

Optional
SPIDER BUNGEE
Sold Separately



INSIDE VIEW

LIGHTNING LT

LIGHT TRUCK DIAGONAL CROSS CABLE DESIGN

SAE CLASS (S) CLEARANCE
RUBBER ADJUSTER INCLUDED FOR QUICK AND EASY
INSTALLATION. CARRYING BAG INCLUDED.

FIND FIT CHART ON PAGES 16-21

(Packed 1 Pair Per Bag, 2 Pair Per Master Carton)

DO NOT USE ON TRAILERS

FIND PRICING IN JOBBER ON WEBSITE

Stock No.	Wt./Pr.	Cross Chain No.	Cross Chain Length
A2014	16	8840	17.6"
A2015	14	8841	15.5"
A2017	14	8842	14.75"
A2019	15	8843	16.75"
A2021	13	8844	16.25"
A2027	14	8845	19.5"
A2029	15	8846	17.25"



STANDARD



SPIDER BUNGEE

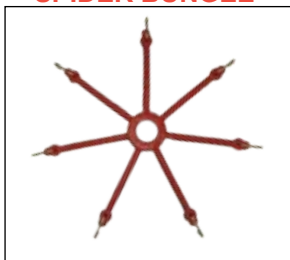

LIGHT TRUCK 7 ARM

PART # 0217

**For Use With
A2000 Series
Cable Chain**

DIAMOND BACK LIGHTWEIGHT 3.7 MM

ALLOY DIAMOND PATTERN
 SINGLE LIGHT TRUCK
 R-V / P-U / VAN
 SQUARE LINK DESIGN

FIND PRICING IN JOBBER ON WEBSITE
HOOP STYLE BACK

PULL CHAIN OR **RUBBER ADJUSTER** TIGHTENING SYSTEM FOR QUICK AND EASY INSTALLATION

DO NOT USE ON TRAILERS
 Packed 1 Pair Per Bag
 Packed 4 Pair Per Master Carton

RUBBER ADJUSTER TYPE

Stock No.	Wt Pr	Cross Chain
2314LW	15	2361LW
2319LW	14	2363LW
2321LW	15	2365LW
2327LW	16	2367LW
2329LW	15	2369LW



RUBBER ADJUSTER TYPE



INSIDE FASTENER



STANDARD

Stock No.	Wt Pr	Cross Chain
*2315LW	14	2394LW
*2317LW	13	2396LW
*2328LW	16	2373LW
*2335LW	16	2375LW
*2337LW	16	2377LW

* **PULL CHAIN TYPE**



PULL CHAIN TYPE

FOR REPAIR PARTS SEE PAGE 15

DIAMOND BACK SQUARE LINK 5.5 MM

ALLOY DIAMOND PATTERN
SINGLE LIGHT TRUCK
R-V / P-U / VAN
SQUARE LINK DESIGN

FIND PRICING IN JOBBER ON WEBSITE
HOOP STYLE BACK

PULL CHAIN OR **RUBBER ADJUSTER** TIGHTENING SYSTEM FOR QUICK AND EASY INSTALLATION

DO NOT USE ON TRAILERS
Packed 1 Pair Per Bag
Packed 2 Pair Per Master Carton

RUBBER ADJUSTER TYPE

Stock No.	Wt Pr	Cross Chain
2514Q	26	2561
2519Q	27	2563
2521Q	26	2565
2527Q	28	2567
2529Q	26	2569

RUBBER ADJUSTER TYPE



INSIDE FASTENER



STANDARD

Stock No.	Wt Pr	Cross Chain
*2515Q	25	2594
*2517Q	22	2596
*2533Q	25	2573
*2536Q	27	2576
*2539Q	30	2579

* **PULL CHAIN TYPE**

PULL CHAIN TYPE



FOR REPAIR PARTS SEE PAGE 15



LIGHT TRUCK / SUV

LIGHT TRUCK CHAINS

- REGULAR AND CAM STYLE
- SINGLE MOUNT
- DUAL/TRIPLE MOUNT
- ALSO AVAILABLE IN LONG MILEAGE ALLOY (LMC)



CAM

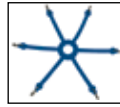

Optional Spider Bungee
Part # 0216
Sold Separately



SINGLE



DUAL TRIPLE

FIND FIT CHART ON PAGES 16-21

FIND PRICING IN JOBBER ON WEBSITE

HIGHWAY SERVICE: NOT FOR Plow, Forklift or Tow Truck-SEE PAGE 28 FOR SIZES

SINGLE MOUNT (1 PAIR PER BAG)				DUAL/TRIPLE MOUNT (1/2 PAIR PER BAG)				Cross Chain No.
REGULAR		CAM-STYLE		REGULAR		CAM-STYLE		
Stock No.	Wt./Pr.	Stock No.	Wt./Pr.	Stock No.	Wt./Pr.	Stock No.	Wt./Pr.	
2209	22	2209QC	22					6219
2211	23	2211QC	25	4211	47	4211QC	52	
2214	28	2214QC	28	4214	49	4214QC	54	
2216	22	2216QC	23	4216	40	4216QC	45	6221
2219	24	2219QC	25	4219	44	4219QC	47	
2221	25	2221QC	27	4221	47	4221QC	50	
2227	26	2227QC	28	4227	50	4227QC	52	6225
2228	28	2228QC	30	4228	51	4228QC	56	
2229	25	2229QC	25	4229	49	4229QC	52	
2233	37	2233QC	38	4233	72	4233QC	79	6251
2237	40	2237QC	42	4237	72	4237QC	93	
2238	38	2238QC	39					6253
2248	50	2248QC	56					6258

LIGHT TRUCK CHAINS: V-BAR

- REGULAR AND CAM STYLE
- SINGLE MOUNT
- DUAL/TRIPLE MOUNT

FIND PRICING IN JOBBER ON WEBSITE
FIND FIT CHART ON PAGES 16-21



CAM

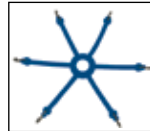

Optional Spider Bungee
Part # 0216
Sold Separately



SINGLE



DUAL TRIPLE

HIGHWAY SERVICE: NOT FOR Plow, Forklift or Tow Truck-SEE PAGE 28 FOR SIZES

SINGLE MOUNT (1 PAIR PER BAG)				DUAL/TRIPLE MOUNT (1/2 PAIR PER BAG)				Cross Chain No.
REGULAR		CAM-STYLE		REGULAR		CAM-STYLE		
Stock No.	Wt./Pr.	Stock No.	Wt./Pr.	Stock No.	Wt./Pr.	Stock No.	Wt./Pr.	
2809	22	2809QC	26					6819
2811	25	2811QC	27	4811	47	4811QC	52	
2814	32	2814QC	33	4814	53	4814QC	58	
2816	24	2816QC	25	4816	44	4816QC	46	6821
2819	26	2819QC	27	4819	48	4819QC	53	
2821	29	2821QC	31	4821	52	4821QC	57	
2827	30	2827QC	30	4827	55	4827QC	55	6825
2828	32	2828QC	34	4828	60	4828QC	61	
2829	27	2829QC	29	4829	54	4829QC	55	
2833	44	2833QC	42	4833	79	4833QC	84	6822
2837	45	2837QC	46	4837	96	4837QC	90	
2838	43	2838QC	46					6853
2848	56	2848QC	58					6858

DUAL AND WIDE BASE

FOR WIDE TIRES AND DUAL MOUNT APPLICATIONS

REGULAR AND CAM STYLE
HIGHWAY USE ONLY, NOT INTENDED FOR
OFF-ROAD, FORKLIFT, OR SNOW PLOW USE.

FIND PRICING IN JOBBER ON WEBSITE

(Packed 1 Pair Per Bag) 2-LINK SPACING AVAILABLE

REGULAR		CAM-STYLE		
Stock No.	Wt./Pr.	Stock No.	Wt./Pr.	Cross Chain No.
3210	26	3210QC	27	6225
3227	34	3227QC	37	6253
3228	36	3228QC	39	6253
3229	37	3229QC	40	6259
3231	40	3231QC	43	6259
3235	44	3235QC	46	6259
3236	47	3236QC	49	6265
3237	42	3237QC	48	6267
3249	43	3249QC	49	6267
3251	43	3251QC	49	6267
3254	63	3254QC	64	7213
3255	66	3255QC	69	7213
3257	72	3257QC	78	7213
3259	58	3259QC	60	7214

Part # 0216

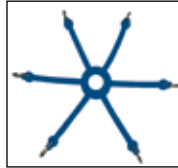

Optional
SPIDER BUNGEE
Sold Separately



SINGLE



DUAL

LIGHT TRUCK / SUV

V-BAR REINFORCED: WIDE BASE

SINGLE MOUNT

HIGHWAY USE ONLY, NOT INTENDED FOR
OFF-ROAD, FORKLIFT OR SNOW PLOW USE.

(Packed 1 Pair Per Bag)

FIND PRICING IN JOBBER ON WEBSITE

REGULAR		CAM-STYLE		
Stock No.	Wt./Pr.	Stock No.	Wt./Pr.	Cross Chain No.
3810	30	3810QC	29	6825
3827	40	3827QC	42	6853
3828	39	3828QC	40	6853
3829	46	3829QC	47	6859
3831	44	3831QC	51	6859
3835	50	3835QC	50	6859
3836	57	3836QC	60	6865



CAM



SQUARE LINK TRUCK CHAINS WIDE BASE

TYPE SLC: SUPER LONG LIFE SQUARE LINK ALLOY CAM

HEAVY DUTY SQUARE LINK TYPE RHD: NON-CAM

Also Available In Heavy Duty Cam Style Type [HDQC]

(Packed 1 Pair Per Bag)



FIND PRICING IN JOBBER ON WEBSITE

9/32" (7 MM)

Stock No.	Wt./Pr.	Cross Chain No.
3110SLC	29	6225SL
3127SLC	39	6253SL
3129SLC	42	6259SL
3131SLC	50	6259SL
3135SLC	54	6259SL

5/16" (8 MM)

Stock No.	Wt./Pr.	Cross Chain No.
3110RHD	43	6251SLX
3127RHD	45	6260SLX
3129RHD	49	6263SLX
3131RHD	57	6263SLX
3135RHD	58	6263SLX

SQUARE LINK LIGHT TRUCK CHAINS



FIND PRICING IN JOBBER ON WEBSITE

REGULAR AND HEAVY DUTY

TYPE **SLC**: Super Long Life Alloy Square Link (5.5 MM)

TYPE **RHD**: Heavy Duty Square Link Alloy Non-Cam (7 MM)

Also Available In Heavy Duty Cam Style Type [HDQC] (7 MM)



5.5 MM SLC



7 MM RHD

5.5 MM (Packed 1 Pair Per Bag) (Packed 1/2 Pair Per Bag)

SINGLE			DUAL/TRIPLE		
Stock No.	Wt./Pr.	Cross Chain No.	Stock No.	Wt./Pr.	Cross Chain No.
2114SLC	33	6221SL	4114SLC	55	6221SL
2116SLC	25	6221SL	4116SLC	53	6221SL
2119SLC	26	6221SL	4119SLC	59	6221SL
2121SLC	28	6221SL	4121SLC	52	6221SL
2127SLC	32	6225SL	4127SLC	68	6225SL
2128SLC	32	6225SL	4128SLC	55	6225SL
2129SLC	29	6225SL	4129SLC	56	6225SL

7 MM (Packed 1 Pair Per Bag) (Packed 1/2 Pair Per Bag)

SINGLE			DUAL/TRIPLE		
Stock No.	Wt./Pr.	Cross Chain No.	Stock No.	Wt./Pr.	Cross Chain No.
2114RHD	40	6250SL	4114RHD	79	6250SL
2116RHD	31	6250SL	4116RHD	60	6250SL
2119RHD	36	6250SL	4119RHD	65	6250SL
2121RHD	38	6250SL	4121RHD	68	6250SL
2127RHD	36	6253SL	4127RHD	70	6253SL
2128RHD	38	6253SL	4128RHD	76	6253SL
2129RHD	39	6253SL	4129RHD	66	6253SL

9/32" (7 MM)

2137SLC	47	6251SL	4137SLC	97	6251SL
2138SLC	45	6253SL	4138SLC	90	6253SL
2139SLC	61	6251SL	4139SLC	116	6251SL

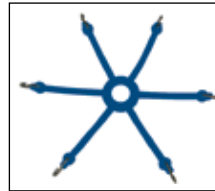

Optional
SPIDER BUNGEE
Sold Separately
Part # 0216

MUD SERVICE

LIGHT TRUCK CHAIN
HEAVY DUTY CROSS CHAIN
EXTRA HEAVY HOOKS

FIND PRICING IN JOBBER ON WEBSITE



SINGLE MOUNT

(Packed 1 Pair Per Bag)



DUAL/TRIPLE MOUNT

(Packed 1/2 Pair Per Bag)

TIRE SIZE	SINGLE			DUAL/TRIPLE		
	Stock No.	Wt./Pr	Cross Chain	Stock No.	Wt./Pr	Cross Chain
215/75-15; 205/75-16; 8.00-16.5;	2433HH	36	6256HH			
9.00-15; 7.00-16; 235/75-15; 225/75-16; 215/85-16	2435HH	39	6256HH			
225/70-19.5	2437HH	45	6256HH	4419HH	83	6256HH
7.50-16; 9.50-16.5; 245/70-15; 255/70-16; 235/85-16	2437HH	45	6256HH	4412HH	80	6256HH
265/75-16; 265/85-16; 265/70-17; 225/70-17.5; 245/70-19.5	2439HH	46	6260HH	4425HH	85	6260HH
285/75-16; 275/70-17.5; 285/70-17	2440HH	48	6260HH			
10.00-15; 7.50-20	2441HH	72	6434HH			

THIS IS A GUIDE ONLY — ACTUAL FITMENT MAY VARY

TRUCK

Tire Size	Volt Truck	Cobra Cable	Lightning Cable	Regular Single	Regular Dual Triple	V-Bar Single	V-Bar Dual Triple	LMC Alloy Single	Square Link Single	Twisted Square Link	HD Sq. Link Single	Mud Service Single	Wide Base / Duals
	QV800	2300	A800	2200	4200	2800	4800	2200LMC	2100SLC	2100Twist	2100RHD	2400HH	3200
	Pg.# 32	Pg.# 33	Pg.# N/A	Pg.# 34	Pg.# 34	Pg.# 34	Pg.# 34	Pg.# 35	Pg.# 36	Pg.# 36	Pg.# 36	Pg.# 35	Pg.# 37
8.25-15	QV835												
9.00-15	QV837	2314	A2029	2237	4237	2837	4837	2237LMC	2137SLC	2137 Twist	2137RHD	2435HH	
10.00-15	QV853												
9.50-16	QV837												
9.5-17.5	QV837												
10-17.5	QV841												
8-19.5		1663		2214	4214	2814	4814	2214LMC	2114SLC	2114 Twist	2114RHD	2439HH	
15-19.5		3065											3265
16.5-19.5		3055	A891										3255
18-19.5		3057											3257
6.50-20				2233	4233	2833	4833	2233LMC	2133SLC	2133 Twist	2133RHD		3259
7.00-20		1663		2233	4233	2833	4833	2233LMC	2133SLC	2133 Twist	2133RHD		3265
7.50-20		2314		2237	4237	2837	4837	2237LMC	2137SLC	2137 Twist	2137RHD	2441HH	3267
8.25-20	QV859	2314		2239	4239	2839	4839	2239LMC	2139SLC	2139 Twist	2139RHD	2441HH	3269
9.00-20	QV869	2315		2241	4241	2841	4841	2241LMC	2141SLC	2141 Twist	2141RHD	2445HH	3273
10.00/90-20	QV877												
10.00-20	QV881	2316	A881	2245	4245	2845	4845	2245LMC	2145SLC	2145 Twist	2145RHD	2448HH	3275
11.00-20	QV887	2317	A887	2251	4251	2851	4851	2251LMC	2151SLC	2151 Twist	2151RHD	2452HH	3277
11.50-20	QV887												
12.00-20	QV891	2317	A891	2255	4255	2855	4855	2255LMC	2155SLC	2155 Twist	2155RHD	2486HH	3255
10.00-22	QV887	2317	A887	2249	4249	2849	4849	2249LMC	2149SLC	2149 Twist	2150RHD	2452HH	3277
11.00-22	QV891	2317	A891	2255	4255	2855	4855	2255LMC	2155SLC	2155 Twist	2155RHD	2452HH	3277
7-22.5		1663		2233	4233	2833	4833	2233LMC	2133SLC	2133 Twist	2133RHD	2439HH	3259
7.50-22.5	QV865												
8-22.5				2237	4237	2837	4837	2237LMC	2137SLC	2137 Twist	2137RHD		3267
8.25-22.5	QV865												
9-22.5	QV859	2314		2239	4239	2839	4839	2239LMC	2139SLC	2139 Twist	2139RHD	2441HH	3269
10-22.5	QV869	2315		2241	4241	2841	4841	2241LMC	2141SLC	2141 Twist	2141RHD	2445HH	3273
11-22.5	QV881	2316	A881	2245	4245	2845	4845	2245LMC	2145SLC	2145 Twist	2145RHD	2448HH	3275
11.5-22.5	QV881												
12-22.5	QV887	2317	A887	2251	4251	2851	4851	2251LMC	2151SLC	2151 Twist	2151RHD	2452HH	3277
12.5-22.5	QV887	2317	A887	2255	4255	2855	4855	2255LMC	2155SLC	2155 Twist	2155RHD	2452HH	3277
12.75-22.5	QV891												
13-22.5	QV891												
15-22.5		3055	A891										3255
16.5-22.5		3071	A896										3271
18-22.5		3061	A898										3261
11.00-24	QV891	2317	A887	2253	4253	2853	4853	2253LMC	2153SLC	2153 Twist	2153RHD	2470HH	
12.00-24				2257	4257	2857	4857	2257LMC	2157SLC	2157 Twist	2157RHD		
11-24.5	QV887	2317	A887	2249	4249	2849	4849	2249LMC	2149SLC	2149 Twist	2150RHD	2452HH	3277
12-24.5		2317	A887	2255	4255	2855	4855	2255LMC	2155SLC	2155 Twist	2155RHD	2486HH	3255
12.5-24.5	QV891												
295/75-17.5	QV859												
225/70-19.5	QV747	1663		2214	4214	2814	4814	2214LMC	2114SLC	2114 Twist	2114RHD	2437HH	
245/70-19.5	QV835	1675		2228	4228	2828	4828	2228LMC	2128SLC	2128 Twist	2128RHD	2439HH	
255/70-19.5	QV835												
265/70-19.5	QV837	2314		2237	4237	2837	4837	2237LMC	2137SLC	2137 Twist	2137RHD		
275/70-19.5	QV837												
285/70-19.5	QV853	2315		2246	4246	2846	4846	2246LMC	2146SLC	2146 Twist	2146RHD		
295/70-19.5	QV853												
305/70-19.5				2239	4239	2839	4839	2239LMC	2139SLC	2139 Twist	2139RHD		
265/75-19.5	QV837												
445/65-19.5	QV896												
325/80-16	QV859												
305/85-16	QV853												

THIS IS A GUIDE ONLY.

ACTUAL FITMENT MAY VARY

VARY AND CLEARANCES

VARY, PLEASE CHECK

SEE LOADER FIT CHART PAGES

** Cam Style available for most applications - Add (QC)**

TRUCK CHAIN FIT CHART

THIS IS A GUIDE ONLY — ACTUAL FITMENT MAY VARY

Tire Size	Volt Truck	Cobra Cable	Lightning Cable	Regular Single	Regular Dual Triple	V-Bar Single	V-Bar Dual Triple	LMC Alloy Single	Square Link Single	Twisted Square Link	HD Sq. Link Single	Mud Service Single	Wide / Base Duals
	QV800	2300	A800	2200	4200	2800	4800	2200LMC	2100SLC	2100TWIST	2100RHD	2400HH	3200
	Pg.# 32	Pg.# 33	Pg.# N/A	Pg.# 34	Pg.# 34	Pg.# 34	Pg.# 34	Pg.# 35	Pg.# 36	Pg.# 36	Pg.# 36	Pg.# 35	Pg.# 37
325/75-17	QV853												
375/60-18	QV853												
13/80-20				2255	4255	2855	4855	2255LMC	2155SLC	2155 Twist	2155RHD	2448HH	3255
14/80-20	QV892			2257	4257	2857	4857	2257LMC	2157SLC	2157 Twist	2157RHD		3255
285/65-20	QV853												
400/70-20	QV892												
335/80-20													3254
365/80-20	QV892	3055	A891										3255
395/85-20	QV898		A896	2612									
44/1800-20			A898										
315/60-22	QV865												
320/75-24	QV887												
495/45-22.5				SEE LOADER FIT CHART PAGES									
445/50-22.5	QV897	3069	A898										3269
425/55-22.5	QV896		A896										3271
445/55-22.5	QV897	3069											3269
455/55-22.5	QV899	3071											3271
495/55-22.5				SEE LOADER FIT CHART PAGES									
285/65-22.5	QV869												
385/65-22.5	QV892	3055	A898										3255
425/65-22.5	QV896	3071	A896										3271
445/65-22.5		3061	A898										3261
225/70-22.5		1669		2233	4233	2833	4833	2233LMC	2133SLC	2133 Twist	2133RHD		
245/70-22.5	QV853	2314		2239	4239	2839	4839	2239LMC	2139SLC	2139 Twist	2139RHD	2441HH	3269
255/70-22.5	QV859	2314		2239	4239	2839	4839	2239LMC	2139SLC	2139 Twist	2139RHD	2441HH	3269
275/70-22.5	QV869	2316	A881	2241	4241	2841	4841	2241LMC	2141SLC	2141 Twist	2141RHD	2445HH	
295/70-22.5	QV877												
305/70-22.5	QV881												
315/70-22.5	QV881												
365/70-22.5	QV892	3055											3255
425/70-22.5	QV898												
235/75-22.5				2239	4239	2839	4839	2239LMC	2139SLC	2139 Twist	2139RHD		
245/75-22.5	QV859	2314		2241	4241	2841	4841	2241LMC	2141SLC	2141 Twist	2141RHD	2441HH	
255/75-22.5	QV859												
265/75-22.5	QV865	2316	A881	2241	4241	2841	4841	2241LMC	2141SLC	2141 Twist	2141RHD	2445HH	
275/75-22.5	QV877												
285/75-22.5	QV877	2316	A881	2247	4247	2847	4847	2247LMC	2147SLC	2147 Twist	2147RHD	2448HH	
295/75-22.5	QV881	2316	A881	2247	4247	2847	4847	2247LMC	2147SLC	2147 Twist	2147RHD	2448HH	3275
235/80-22.5		2314		2239	4239	2839	4839	2239LMC	2139SLC	2139 Twist	2139RHD	2441HH	3269
245/80-22.5	QV859												
255/80-22.5	QV865	2315		2241	4241	2841	4841	2241LMC	2141SLC	2141 Twist	2141RHD	2441HH	3269
275/80-22.5	QV881	2316	A881	2245	4245	2845	4845	2245LMC	2145SLC	2145 Twist	2145RHD	2445HH	3273
295/80-22.5	QV881	2317	A887	2251	4251	2851	4851	2251LMC	2151SLC	2151 Twist	2151RHD	2448HH	3273
305/80-22.5	QV881	2317	A887	2251	4251	2851	4851	2251LMC	2151SLC	2151 Twist	2151RHD	2452HH	3277
315/80-22.5	QV887	2317	A887	2255	4255	2855	4855	2255LMC	2155SLC	2155 Twist	2155RHD	2486HH	3277
365/80-22.5		3055	A891										3255
275/85-22.5		2316	A881	2247	4247	2847	4847	2247LMC	2147SLC	2147 Twist	2147RHD		
305/85-22.5	QV892			2251	4251	2851	4851	2251LMC	2151SLC	2151 Twist	2151RHD		
285/70-24.5	QV881												
285/75-24.5	QV881	2316	A881	2249	4249	2849	4849	2249LMC	2149SLC	2149 Twist	2150RHD	2452HH	3275
295/75-24.5	QV881												
305/75-24.5	QV887	2317	A887	2255	4255	2855	4855	2255LMC	2155SLC	2155 Twist	2155RHD	2452HH	3277
315/75-24.5		3055	A891	2255	4255	2855	4855	2255LMC	2155SLC	2155 Twist	2155RHD	2452HH	3277
275/80-24.5	QV881	2316	A881	2247	4247	2847	4847	2247LMC	2147SLC	2147 Twist	2147RHD	2452HH	3273
285/80-24.5	QV881	2317	A887	2249	4249	2849	4849	2249LMC	2149SLC	2149 Twist	2150RHD	2452HH	

THIS IS A GUIDE ONLY.

ACTUAL FITMENT MAY VARY AND CLEARANCES

VARY, PLEASE CHECK

** Cam Style available for most applications - Add (QC)**

WWW.QUALITYCHAINCORP.COM



STATE CHAIN REQUIREMENTS

THIS IS A GUIDE ONLY—ACTUAL CHAIN REQUIREMENTS MAY VARY FROM STATE TO STATE

CHAINING DIAGRAM

DUAL AXLE

ONE SET OF LINK COVERING THE OUTSIDE TIRES ON PRIMARY DRIVE AXLE, ALL OTHER POSITIONS CAN BE CABLE

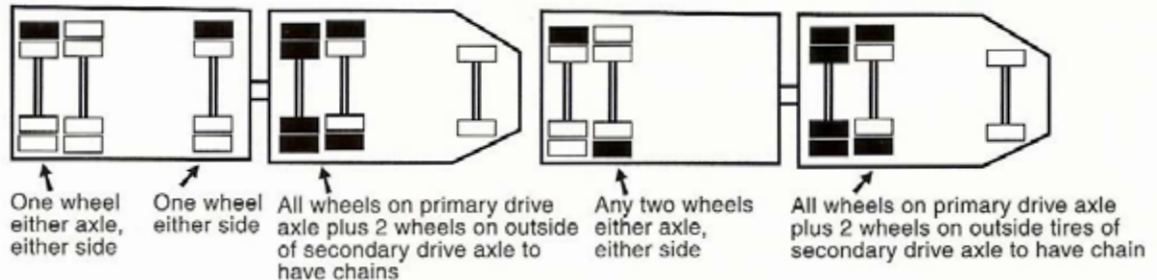

SINGLE AXLE

LINK CHAIN REQUIRED ON ALL DRIVE TIRES

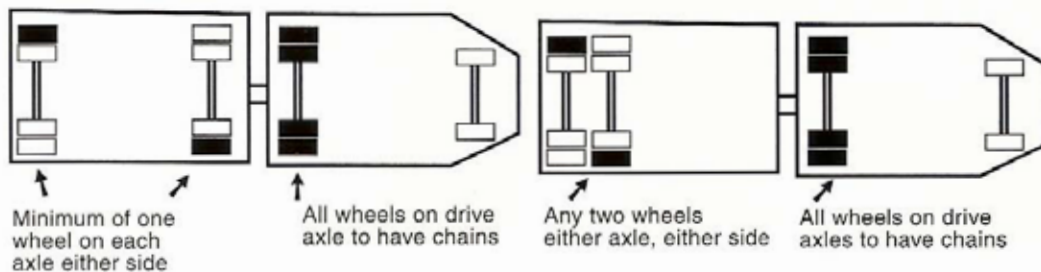

FOR MORE STATE SPECIFIC CHAIN REGULATIONS PLEASE VISIT EACH INDIVIDUAL STATES DEPARTMENT OF TRANSPORTATIONS WEB SITE

Oregon - <http://www.tripcheck.com/Pages/RCMap.asp?mainNav=RoadConditions&staticNav=MinChainReqs>

Washington - http://www.wsdot.wa.gov/commercialvehicle/chain_req.htm

California - <http://www.dot.ca.gov/hq/traffops/trucks/ops-guide/chains.html>

Nevada - <http://www.nevadadot.com/safety/winter/chains.aspx>

Wyoming - http://www.dot.state.wy.us/wydot/travel/winter/chain_law

Colorado - <http://www.coloradodot.info/library/Brochures/ChainTips.pdf>

NEW VOLT TRUCK

PREMIUM COMMERCIAL TRUCK



STANDARD

Volt Truck cable chains were designed with the truck driver in mind; easy installation, long life and great traction were key. The cross chain are made of Manganese **ALLOY ROLLERS** providing unbeatable longevity, and the cross cable design offers a very smooth ride reducing vibration.

.685" Diameter Cross Chain Rollers
Exceed All "Minimum" State Regulations

SOLD WITH RUBBER ADJUSTER AND ADJUSTER TOOL
(Packed 1 Pair Per Cardboard Box)

[FIND PRICING IN JOBBER ON WEBSITE](#)

PART #	WT.	CROSS CHAIN	BUNGEE
QV835	35.10	QV8259	QV1882
QV837	37.00	QV8261	QV1882
QV841	36.80	QV8261	QV1882
QV853	36.65	QV8263	QV1882
QV859	38.50	QV8263	QV1882
QV865	38.10	QV8263	QV1882
QV869	38.35	QV8263	QV1882
QV877	39.50	QV8265	QV1882
QV881	38.80	QV8263	QV1870
QV887	39.25	QV8265	QV1870

PART #	WT.	CROSS CHAIN	BUNGEE
QV891	42.45	QV8267	QV1882
QV892	40.60	QV8267	QV1882
QV896	48.25	QV8275	QV1882
QV897	43.65	QV8269	QV1870
QV898	48.00	QV8283	QV1876
QV899	44.50	QV8277	QV1870

SINGLE



WIDE BASE



COBRA™ CABLE CHAINS

HEAVY TRUCK / BUS

Full 4" tightening
 Extra heavy duty side cable and rollers
 Heat treated/case hardened for longer wear

(Singles Packed 1 Pair Per Box or Bag)

(Dual/Triples Packed 1/2 Pair Per Box)



SINGLE



DUAL

FIND PRICING IN JOBBER ON WEBSITE

TIRE SIZE	SINGLES			DUAL / TRIPLES		
	Stock No.	Wt./Pr.	Cross Chain No.	Stock No.	Wt./Pr.	Cross Chain No.
9.00-15; 10.00-15; 8.25-20; 9R22.5; 255/70-22.5; 245/75-22.5; 235/80-22.5; 37X12.50-16.5; 245/70-20; 7.50-20; 315/75-16; 295/75-16; 265/70-19.5; 245/70-22.5	2314	15	8825	4314	29	8825
9.00-20; 10R22.5; 255/80-22.5; 285/70-19.5	2315	16	8825	4315	33	8825
10.00-20; 11R22.5; 275/70-22.5; 285/75-22.5; 295/75-22.5; 265/75-22.5; 275/80-22.5; 275/85-22.5; 285/75-24.5; 275/80-24.5	2316	17	8825	4316	34	8825
11.00-20; 12.00-20; 10.00-22; 11.00-22; 12R22.5; 12.5R22.5; 12.00-24; 12R24.5; 315/80-22.5; 285/80-24.5; 295/80-22.5; 305/75-24.5; 11R24.5; 11.00-24	2317	18	8825	4317	37	8825

Part # 0218

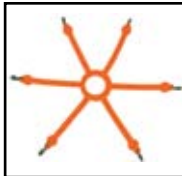

Optional
HD Spider Bungee
 Sold Separately



INSIDE FASTENER



WIDE BASE

(Packed 1 Pair Per Box)

FIND PRICING IN JOBBER ON WEBSITE

TIRE SIZE	SUPER SINGLES		
	Stock No.	Wt./Pr.	Cross Chain No.
16.5-19.5; 15R22.5; 385/65-22.5; 315/75-24.5; 365/80-20; 365/80-22.5; 365/70R22.5	3055	19	8813
18-19.5	3057	23	8813
19.5R19.5; 18R22.5; 445/65-22.5	3061	23	8814
15R19.5; 14X36.5-15	3065	22	8815
445/50-22.5; 445/55-22.5	3069	21	8815
16.5R22.5; 425/65-22.5; 425/55R22.5; 455/55-22.5	3071	22	8815

TRUCK CHAINS:

- REGULAR AND CAM STYLE
- SINGLE MOUNT
- DUAL/TRIPLE MOUNT



CAM



FIND PRICING IN JOBBER ON WEBSITE

HIGHWAY SERVICE: **NOT FOR** Plow, Forklift or Tow Truck-SEE PAGE 36 FOR CHAINS

SINGLE MOUNT				DUAL/TRIPLE MOUNT				Cross Chain No.
REGULAR		CAM-STYLE		REGULAR		CAM-STYLE		
Stock No.	Wt./Pr.	Stock No.	Wt./Pr.	Stock No.	Wt./Pr.	Stock No.	Wt./Pr.	
2233	27	2233QC	38	4233	72	4233QC	79	6251
2237	40	2237QC	42	4237	89	4237QC	93	
2239	42	2239QC	44	4239	78	4239QC	79	
2241	46	2241QC	47	4241	82	4241QC	86	
2245	48	2245QC	51	4245	90	4245QC	91	
2246	45	2246QC	47	4246	82	4246QC	85	6253
2247	47	2247QC	50	4247	89	4247QC	91	
2248	50	2248QC	50					6258
2249	50	2249QC	54	4249	94	4249QC	97	6253
2251	62	2251QC	66	4251	121	4251QC	123	6260
2253	77	2253QC	79	4253	137	4253QC	141	
2255	70	2255QC	73	4255	128	4255QC	128	6263
2257	78	2257QC	82	4257	145	4257QC	150	
2271	82	2271QC	90	4271	154	4271QC	162	6266
2273	84	2273QC	92	4273	171	4273QC	183	

TRUCK CHAINS: V-BAR

- REGULAR AND CAM STYLE
- SINGLE MOUNT
- DUAL/TRIPLE MOUNT



CAM



FIND PRICING IN JOBBER ON WEBSITE

HIGHWAY SERVICE: **NOT FOR** Plow, Forklift or Tow Truck-SEE PAGE 36 FOR CHAINS

SINGLE MOUNT				DUAL/TRIPLE MOUNT				Cross Chain No.
REGULAR		CAM-STYLE		REGULAR		CAM-STYLE		
Stock No.	Wt./Pr.	Stock No.	Wt./Pr.	Stock No.	Wt./Pr.	Stock No.	Wt./Pr.	
2833	41	2833QC	42	4833	79	4833QC	84	6822
2837	45	2837QC	46	4837	96	4837QC	90	
2839	46	2839QC	52	4839	85	4839QC	94	
2841	50	2841QC	54	4841	91	4841QC	104	
2845	57	2845QC	60	4845	100	4845QC	104	
2846	49	2846QC	52	4846	93	4846QC	95	6853
2847	55	2847QC	57	4847	104	4847QC	107	
2848	56	2848QC	58					6858
2849	60	2849QC	59	4849	103	4849QC	112	6853
2851	71	2851QC	75	4851	131	4851QC	133	6860
2853	82	2853QC	83	4853	147	4853QC	152	
2855	74	2855QC	78	4855	140	4855QC	140	6863
2857	86	2857QC	87	4857	152	4857QC	157	
2871	94	2871QC	95	4871	165	4871QC	170	6866
2873	95	2873QC	97	4873	183	4873QC	188	

LONG MILEAGE ALLOY TRUCK CHAINS

Long Mileage, **LMC** Cam Type **Alloy** Cross Chain
HEAVY TRUCK / BUS

Constructed of alloy steel for extra wear.

FIND PRICING IN JOBBER ON WEBSITE



9/32" (7 MM)

(Packed 1 Pair Per Bag)

(Packed 1/2 Pair Per Bag)

TIRE SIZE	SINGLE			DUAL/TRIPLE		
	Stock No.	Wt./Pr.	Cross Chain No.	Stock No.	Wt./Pr.	Cross Chain No.
9.00R20; 10R22.5; 265/75R22.5; *275/80R22.5; 255/80R22.5; 245/75R22.5	2241LMC	47	6251LM	4241LMC	86	6251LM
10.00R20; 11R22.5; *275/80R24.5; *295/75R22.5; *285/75R22.5; *275/80R22.5	2245LMC	52	6251LM	4245LMC	92	6251LM
275/80R24.5; *285/75R24.5; *295/75R22.5; *285/75R22.5	2247LMC	49	6253LM	4247LMC	90	6253LM
11R24.5; *285/75R24.5; 10.00R22; 285/80R24.5	2249LMC	53	6253LM	4249LMC	96	6253LM

5/16" (8 MM)

11.00R20; 12R22.5; 295/80R22.5	2251LMC	66	6260LM	4251LMC	123	6260LM
11.00R24	2255LMC	73	6263LM	4255LMC	128	6263LM

EXTRA-DURABLE TRUCK CHAINS

Extra-Durable, **XD** Heavy Truck / Bus Cam Type

Heavy Duty **Alloy** Cross Chain

Constructed of heavy duty alloy steel for extra wear.

FIND PRICING IN JOBBER ON WEBSITE

5/16" (8 MM)

(Packed 1 Pair Per Bag)

(Packed 1/2 Pair Per Bag)

TIRE SIZE	SINGLE			DUAL/TRIPLE		
	Stock No.	Wt./Pr.	Cross Chain No.	Stock No.	Wt./Pr.	Cross Chain No.
10.00R20; 11R22.5; 275/80R22.5; *275/80R24.5	2245XDQC	64	7465XD	4245XDQC	115	7465XD
*275/80R24.5; *285/75R24.5; *295/75R22.5; *285/75R22.5	2247XDQC	66	7465XD	4247XDQC	122	7465XD
10.00R22; 11R24.5; *285/75R24.5; 285/80R24.5	2249XDQC	70	7465XD	4249XDQC	123	7465XD

MUD SERVICE TRUCK CHAINS

SINGLE MOUNT DUAL/TRIPLE MOUNT
HEAVY DUTY CROSS CHAIN WITH
EXTRA HEAVY HOOKS



FIND PRICING IN JOBBER ON WEBSITE

3/8" (10 MM)

(Packed 1 Pair Per Bag)

(Packed 1/2 Pair Per Bag)

TIRE SIZE	SINGLE			DUAL/TRIPLE		
	Stock No.	Wt./Pr.	Cross Chain No.	Stock No.	Wt./Pr.	Cross Chain No.
8.25-20; 9-22.5; 7.50-20; 10.00-15; 8.25-15; 11R15; 8.5-17.5; 245/75-22.5; 255/70-22.5; 35X12.50-16.5; 245/70-22.5; 36X12.50-16.5; 245/85-15; 265/70-16; 235/80-22.5; 255/80-22.5	2441HH	72	6434HH	4435HH	136	6256HH
9.00-20; 10-22.5; 265/75-22.5; *275/80-22.5; 275/70-22.5; 37X12.50-15; 315/75-16	2445HH	77	6434HH	4437HH	148	6434HH
10.00-20; 11-22.5; *275/80-22.5; 295/75-22.5; 285/75-22.5; 295/80-22.5	2448HH	84	6434HH	4448HH	153	6434HH
11.00-20; 10.00-22; 12-22.5; 11-24.5; 12.5-22.5; 285/75-24.5; 275/80-24.5; 305/75-24.5; 315/75-24.5; 285/80-24.5	2452HH	89	6434HH	4461HH	166	6434HH
11.00-24	2470HH	116	6438HH	4470HH	201	6438HH
12.00-20; 11.00-22; 12-24.5; 315/80-22.5; 13/80-20	2486HH	102	6438HH	4486HH	188	6438HH

*MORE THAN ONE POSSIBLE CHAIN FITMENT

SQUARE LINK TRUCK CHAINS

REGULAR AND HEAVY DUTY

TYPE **SLC**: Super Long Life **Alloy** Square Link Cam, TYPE **SL**: Non-Cam



ALLOY

9/32" (7 MM) (SINGLES Packed 1 Pair Per Bag) (DUALS Packed 1/2 Pair Per Bag)

FIND PRICING IN JOBBER ON WEBSITE

CAM				NON-CAM				Cross Chain No.
SINGLE		DUAL/TRIPLE		SINGLE		DUAL/TRIPLE		
Stock No.	Wt. /Pr.	Stock No.	Wt. /Pr.	Stock No.	Wt. /Pr.	Stock No.	Wt. /Pr.	
2137SLC	47	4137SLC	92	2137SL	46	4137SL	90	6251SL
2139SLC	53	4139SLC	97	2139SL	57	4139SL	114	6251SL
2141SLC	56	4141SLC	105	2141SL	61	4141SL	114	6251SL
2145SLC	60	4145SLC	111	2145SL	66	4145SL	115	6251SL
2147SLC	61	4147SLC	112	2147SL	60	4147SL	123	6253SL
2149SLC	65	4149SLC	123	2149SL	65	4149SL	123	6253SL

5/16" (8 MM)

2151SLC	70	4151SLC	129	2151SL	79	4151SL	152	6260SL
2155SLC	74	4155SLC	138	2155SL	74	4155SL	172	6263SL



SINGLE



DUAL

TYPE **RHD**: Heavy Duty Square Link **Alloy** Non-Cam
 TYPE **HDQC**: Heavy Duty Square Link **Alloy** Cam Style

5/16" (8 MM)

HEAVY DUTY

CAM			NON-CAM				Cross Chain No.	
SINGLE		DUAL/TRIPLE	SINGLE		DUAL/TRIPLE			
Stock No.	Wt. /Pr.	Stock No.	Wt. /Pr.	Stock No.	Wt. /Pr.	Stock No.	Wt. /Pr.	
2141HDQC	62	4141HDQC	146	2141RHD	78	4141RHD	115	6260SL
2145HDQC	69	4145HDQC	123	2145RHD	74	4145RHD	124	6260SL
2150HDQC	74	4150HDQC	136	2150RHD	72	4150RHD	133	6263SL

Part # 0218

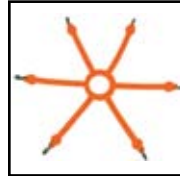

*Optional
 HD Spider Bungee
 Sold Separately*



CAM

"TWISTED" SQUARE LINK TRUCK CHAINS

REGULAR AND HEAVY DUTY

TYPE **SLC TWIST**: Super Long Life **Alloy TWIST** Square Link Cam
 (SINGLES Packed 1 Pair Per Bag) (DUALS Packed 1/2 Pair Per Bag)

9/32" (7 MM)

FIND PRICING IN JOBBER ON WEBSITE

SINGLE		DUAL/TRIPLE		Cross Chain No.
Stock No.	Wt. /Pr.	Stock No.	Wt. /Pr.	
2137SLC TWIST	50	4137SLC TWIST	94	6251SL TWIST
2139SLC TWIST	54	4139SLC TWIST	99	6251SL TWIST
2141SLC TWIST	59	4141SLC TWIST	107	6251SL TWIST
2145SLC TWIST	63	4145SLC TWIST	119	6251SL TWIST
2147SLC TWIST	63	4147SLC TWIST	123	6253SL TWIST
2149SLC TWIST	66	4149SLC TWIST	128	6253SL TWIST

5/16" (8 MM)

2151SLC TWIST	73	4151SLC TWIST	134	6260SL TWIST
2155SLC TWIST	76	4155SLC TWIST	174	6263SL TWIST



SINGLE



DUAL

TYPE **RHD**: Heavy Duty **TWIST** Square Link **Alloy** Non-Cam

Also Available In Cam Style [HDQC TWIST]

5/16" (8 MM)

HEAVY DUTY

SINGLE	WT./PR	DUAL/TRIPLE	WT./PR	Cross Chain
2141RHD TWIST	78	4141RHD TWIST	156	6260SL TWIST
2145RHD TWIST	84	4145RHD TWIST	126	6260SL TWIST
2150RHD TWIST	89	4150RHD TWIST	157	6263SL TWIST

DUAL AND WIDE BASE CAM STYLE AVAILABLE (ADD QC TO END OF PART #)

HIGHWAY USE ONLY, NOT INTENDED FOR OFF-ROAD, FORKLIFT, OR SNOW PLOW USE.

(Packed 1 Pair Per Bag)

[FIND PRICING IN JOBBER ON WEBSITE](#)



SINGLE MOUNT



DUAL MOUNT



LONG MILEAGE (LMC)

TIRE SIZE		REGULAR			LONG MILEAGE ALLOY		
		Stock No.	Wt./Pr.	Cross Chain No.	Stock No.	Wt./Pr.	Cross Chain No.
Single Mount	Dual Mount						
16.5-19.5; 15-22.5; 385/65R22.5; 13/80R20; 365/70R22.5; 14/80R20; 365/80R22.5; 14X36.5-15; 12.00-20; 12-24.5		3255	68	7213	3255LMC	72	7213LM
18-19.5; 445-65X19.5		3257	73	7213	3257LMC	74	7213LM
	8-19.5; 7-22.5; 6.50-20	3259	60	7214	3259LMC	61	7214LM
365/80R20; 18-22.5; 445/65R22.5; 19.5-19.5		3261	80	7214	3261LMC	82	7214LM
38X15X16LT; 15-19.5; 15.50/60R18	7.00-20	3265	59	7215	3265LMC	64	7215LM
42X15-15LT	7.50-20; 8-22.5	3267	67	7215	3267LMC	69	7215LM
44X18.5X15; 44X18.5X16.5; 445/50R22.5; 445/55R22.5	8.25-20; 9-22.5; 245/70R22.5; 235/80R22.5; 255/70R22.5; 255/80R22.5	3269	70	7215	3269LMC	70	7215LM
425/65R22.5; 425/55R22.5; 455/55/22.5		3271	73	7215	3271LMC	79	7215LM
	275/80R24.5; 9.00-20; 10-22.5; 275/80R22.5; 295/80R22.5	3273	79	7216	3273LMC	81	7216LM
38/2700-17.5	295/75R22.5; 11-22.5; 285/75R24.5; 10.00-20	3275	83	7216	3275LMC	85	7216LM
	315/80R22.5; 305/75R24.5; 11.00-20; 315/75R24.5; 11.00-24.5; 10.00-22; 12.5-22.5; 11.00-22; 12-22.5	3277	86	7216	3277LMC	88	7216LM

SQUARE LINK TRUCK CHAINS WIDE BASE

TYPE SLC: SUPER LONG LIFE SQUARE LINK ALLOY CAM

5/16" (8 MM)

(Packed 1 Pair Per Bag)

[FIND PRICING IN JOBBER ON WEBSITE](#)



TIRE SIZE		TYPE SLC 5/16" (8MM)		
		Stock No.	Wt./Pr.	Cross Chain No.
Single Mount	Dual Mount			
16.5-19.5; 15-22.5; 385/65R22.5; 13/80R20; 365/70R22.5; 14/80R20; 365/80R22.5; 14X36.5-15; 12.00-20; 12-24.5		3155SLC	78	7213SL
18-19.5; 445-65X19.5		3157SLC	80	7213SL
	8-19.5; 7-22.5; 6.50-20	3159SLC	78	7214SL
365/80R20; 18-22.5; 445/65R22.5; 19.5-19.5		3161SLC	80	7214SL
38X15X16LT; 15-19.5; 15.50/60R18	7.00-20	3165SLC	78	7215SL
42X15-15LT	7.50-20; 8-22.5	3167SLC	79	7215SL
44X18.5X15; 44X18.5X16.5; 445/50R22.5; 445/55R22.5	8.25-20; 9-22.5; 245/70R22.5; 235/80R22.5; 255/70R22.5; 255/80R22.5	3169SLC	80	7215SL
425/65R22.5; 425/55R22.5; 455/55/22.5		3171SLC	84	7215SL
	275/80R24.5; 9.00-20; 10-22.5; 275/80R22.5; 295/80R22.5	3173SLC	86	7216SL
38/2700-17.5	295/75R22.5; 11-22.5; 285/75R24.5; 10.00-20	3175SLC	93	7216SL
	315/80R22.5; 305/75R24.5; 11.00-20; 315/75R24.5; 11.00-24.5; 10.00-22; 12.5-22.5; 11.00-22; 12-22.5	3177SLC	95	7216SL

**ALSO AVAILABLE
IN HEAVY DUTY
3/8" (10 MM)**

**CAM STYLE
(TYPE HDQC)**

**NON-CAM STYLE
(TYPE RHD)**

LOGGING & MINING CHAINS

Designed specifically for the log trucks with over-sized and deep lugged tires. Made wider, longer and with heavier wire diameters. Available in singles and dual/triples.

[FIND PRICING IN JOBBER ON WEBSITE](#)



TWISTED ALLOY SQUARE LINK 5/16" (8 MM)

TIRE SIZE	STYLE	SINGLE TRUCK CHAIN			DUAL/TRIPLE TRUCK CHAIN		
		Stock No.	Wt./Pr.	Cross Chain No.	Stock No.	Wt./Pr.	Cross Chain No.
11.00-22.5	Regular	2145LSTWIST	70	6260SLTWIST	4145LSTWIST	130	6260SLTWIST
10.00-22; 11.00-24.5	Regular	2150LSTWIST	89	6263SLTWIST	4150LSTWIST	140	6263SLTWIST
12.00-24	Regular	2157LSTWIST	101	6263SLTWIST	4157LSTWIST	151	6263SLTWIST



ALLOY SQUARE LINK 5/16" (8 MM)

TIRE SIZE	STYLE	SINGLE TRUCK CHAIN			DUAL/TRIPLE TRUCK CHAIN		
		Stock No.	Wt./Pr.	Cross Chain No.	Stock No.	Wt./Pr.	Cross Chain No.
11.00-22.5	CAM	2145LSC	69	6260SL	4145LSC	123	6260SL
10.00-22; 11.00-24.5	Regular	2150LS	78	6263SL	4150LS	136	6263SL
	CAM	2150LSC	77	6263SL	4150LSC	138	6263SL
12.00-24	Regular	2157LS	99	6263SL	4157LS	147	6263SL



HIGHWAY SERVICE TYPE LS 5/16" (8 MM)

TIRE SIZE	STYLE	SINGLE TRUCK CHAIN			DUAL/TRIPLE TRUCK CHAIN		
		Stock No.	Wt./Pr.	Cross Chain No.	Stock No.	Wt./Pr.	Cross Chain No.
11.00-22.5	Regular	2245LS	57	6260	4245LS	115	6260
	CAM	2245LSC	62	6260	4245LSC	120	6260
10.00-22; 11.00-24.5	Regular	2250LS	69	6263	4250LS	124	6263
	CAM	2250LSC	71	6263	4250LSC	129	6263



ALLOY HIGHWAY SERVICE 5/16" (8 MM)

TIRE SIZE	STYLE	SINGLE TRUCK CHAIN			DUAL/TRIPLE TRUCK CHAIN		
		Stock No.	Wt./Pr.	Cross Chain No.	Stock No.	Wt./Pr.	Cross Chain No.
10.00-22; 11.00-24.5	Regular	2250LM	69	6263LM	4250LM	124	6263LM
	CAM	2250LMC	71	6263LM	4250LMC	129	6263LM



V-BAR REINFORCED TYPE LS 5/16" (8 MM)

TIRE SIZE	STYLE	SINGLE TRUCK CHAIN			DUAL/TRIPLE TRUCK CHAIN		
		Stock No.	Wt./Pr.	Cross Chain No.	Stock No.	Wt./Pr.	Cross Chain No.
11.00-22.5	Regular	2845LS	64	6860	4845LS	128	6860
	CAM	2845LSC	69	6860	4845LSC	130	6860
10.00-22; 11.00-24.5	Regular	2850LS	76	6863	4850LS	131	6863
	CAM	2850LSC	76	6863	4850LSC	133	6863

THIS IS A GUIDE ONLY — ACTUAL FITMENT MAY VARY

Tire Size	Regular Round Twist	Studded	Square Link	Max Track 3/8"	Max Track 7/16"	Max Track 1/2"	3/8" Studded H-Pattern	7/16" Studded H-Pattern	Duo H-Pattern	Round Twist Tractor
	Pg. # 42	Pg. # 72	Pg. # 42	Pg. # 44	Pg. # 44	Pg. # 44	Pg. # 72	Pg. # 72	Pg. # 49	Pg. # 48
10.5/80-18 Front Backhoe										0832
10-32									DUO218	
10-38									DUO232	
11.2-16									DUO214	
11.2-24									DUO226	0836
11.2-28									DUO226	0838
11.2-32									DUO218	
11.2-34									DUO224	0846
11.2-36									DUO224	0846
11.2-38									DUO232	0862
11.2-44									DUO236	
11.2-48									DUO247	
11.00-16										0822
11-28									DUO218	
11-36									DUO232	
11-38									DUO232	
12.4-24									DUO229	0852
12.4-28									DUO218	0856
12.4-36									DUO232	0862
12.4-38									DUO232	0862
12.4-40									DUO246	
12.4-42									DUO246	
12.4-46									DUO248	
12.4-48									DUO259	
12.4-52									DUO259	
12.4-54									DUO261	
12.5X80-18 Front Backhoe									DUO210	0834
12-28									DUO242	
12-36									DUO246	
13.00-24	2612	9912	6512	8103MT	8111MT		8203	8311	DUO242	
13.5-16.1									DUO214	0838
13.6-24									DUO240	0856
13.6-26									DUO240	0858
13.6-28	2612	9912	6512	8103MT	8111MT		8203	8311	DUO242	0859
13.6-36									DUO246	0866
13.6-38									DUO246	0866
13.9-36									DUO246	0866
14.00-20	2612	9912	6512							
14.00-24	2615	9915	6515	8104MT	8111MT		8204	8311	DUO262	
14.00-25	2615	9915	6515							
14.75-80-20	2612	9912	6512							
14.9-24	2612	9912	6512						DUO242	0859
14.9-26									DUO250	0869
14.9-28									DUO250	0869
14.9-30									DUO252	0876
14.9-38									DUO254	0871
14.9-46									DUO256	
15-19.5 R4 Tire	3265HD								DUO239	0859
15.5-25	2612	9912	6512	8104MT	8111MT		8204	8311		
15.5-38									DUO270	0879
16.00-20	2624	9924	6524		8113MT	8622MT		8313		
16.00-24	2627	9927	6527	8105MT	8112MT		8205	8312		
16.00-25	2627	9927	6527	8105MT	8112MT		8205	8312		
16.9-24	2615	9915	6515	8104MT	8111MT		8204	8311	DUO262	0874

THIS IS A GUIDE ONLY

ACTUAL FITMENT MAY VARY

VARY AND CLEARANCES

VARY, PLEASE CHECK

LOADER - GRADER - TRACTOR

THIS IS A GUIDE ONLY — ACTUAL FITMENT MAY VARY

Tire Size	Regular Round Twist	Studded	Square Link	Max Track 3/8"	Max Track 7/16"	Max Track 1/2"	3/8" Studded H-Pattern	7/16" Studded H-Pattern	Duo H-Pattern	Round Twist Tractor
	Pg. # 42	Pg. # 72	Pg. # 42	Pg. # 44	Pg. # 44	Pg. # 44	Pg. # 72	Pg. # 72	Pg. # 49	Pg. # 48
16.9-26	2615	9915	6515	8104MT	8111MT		8204	8311	DUO262	0876
16.9-28 R1 - R4				8104MT	8111MT		8204	8311	DUO262	0876
16.9-30				8106MT	8110MT		8206	8310	DUO266	0877
16.9-32									DUO266	0877
16.9-34									DUO270	0879
16.9-38									DUO272	0880
17.5-25	2627	9927	6527		8113MT	8622MT		8313	DUO268	
17.5L-24	2615	9915	6515	8104MT	8111MT		8204	8311	DUO262	0874
18.00-25	2636	9936	6536		8114MT	8624MT		8314		
18.00-26	2636	9936	6536							
18.00-33	2642	9942	6542							
18.4-16.1									DUO264	0881
18.4-24									DUO268	0883
18.4-26				8106MT	8110MT		8206	8310	DUO268	0883
18.4-28				8106MT	8110MT		8206	8310	DUO269	0884
18.4-30					8114MT	8624MT		8314	DUO271	0885
18.4-34					8115MT	8626MT		8315	DUO273	0887
18.4-38									DUO274	0889
18.4-42									DUO277	0894
18.4-46									DUO277	
19.5L-24	2627	9927	6527	8105MT	8112MT		8205	8312	DUO268	0883
20.5-25	2633	9933	6533		8114MT	8624MT		8314		
20.8-34					8115MT	8626MT		8315	DUO272	0890
20.8-38									DUO276	0892
20.8-42									DUO285	
21.00-24	2648	9948	6548							
21.00-25	2648	9948	6548		8115MT	8626MT		8315		
21.00-35	2654	9954	6554							
21L-24	2636	9936	6536		8114MT	8624MT		8314	DUO271	0885
23.1-26					8115MT	8626MT		8315	DUO280	0891
23.1-28									DUO280	
23.1-30									DUO281	0893
23.1-34					8114MT	8626MT		8314	DUO282	0895
23.5-25	2645	9945	6545		8115MT	8626MT		8315		
24.5-32						8627MT			DUO278	
24.00-25	2660	9960	6560			8627MT				
24.00-35	2686	9986	6586							
25.5-25	2645	9945	6545							
25/65-25					8115MT	8626MT		8315		
26.5-25	2657	9957	6557			8627MT				
26.5-29	2660	9960	6560			8627MT				
28L-26										
29.5-25	2672	9972	6572			8628MT				
29.5-29	2675	9975	6575			8699MT				
29.5-35	2688	9988	6588							
39.5/85-20	2615	9915	6515							
30.5-32						8628MT			DUO283	
33.5-33	2678	9978	6578							
35/65-33	2680	9980	6580							
37.5-33	2682	9982	6582							
40X19-19.5									DUO264	
8.3-24										0822
8.3-44									DUO228	
9.50-40									DUO228	

THIS IS A GUIDE ONLY.

ACTUAL FITMENT MAY VARY

VARY AND CLEARANCES

VARY, PLEASE CHECK

LOADER - GRADER - TRACTOR



LOADER, GRADER, TRACTOR FIT CHART

THIS IS A GUIDE ONLY — ACTUAL FITMENT MAY VARY

Tire Size	Regular Round Twist	V-Bar	Studded	Square Link 4-Link	Square Link 2-Link	Duo H-Pattern	Round Twist Tractor	Twin Link
	Pg. # 42	Pg. # 42	Pg. # 72	Pg. # 42	Pg. # 42	Pg. # 49	Pg. # 48	Pg. # 48
9.5-16							0829	0729
9.5-18							0822	0722
9.5-24						DUO214	0832	0732
9.5-28						DUO214	0836	0736
9.5-32						DUO226		
9.5-44						DUO227		
9.5-48						DUO236		
12.4-16						DUO229	0836	0736
13.6-16							0850	0750
15-22.5							0852	0752
21.5-16							0882	0782
21.5L-16.1							0882	0782
340/80-18							0836	0736
445/65-19.5	2612	2612V	9912	6512	6512-2			
355/80-20	3257							
38X18-20	3235							
41X14-20						DUO240	0858	0758
43X16-20						DUO239		
400/70-20	2612	2612V	9912	6512	6512-2	DUO240	0858	0758
405/70-20	2612	2612V	9912	6512	6512-2	DUO240		
425/75-20								
44/18.00-20	2612	2612V	9912	6512	6512-2			
480/80-20						DUO277		
625/70-20	2645		9945	6545	6545-2			
495/55-22.5	2612	2612V	9912	6512	6512-2			
320/85-24						DUO229		
340/85-24						DUO240		
380/85-24						DUO242		
385/95-24	2615	2615V	9915	6515	6515-2			
420/70-24	2624		9924	6524	6524-2	DUO242	0859	
460/70-24	2615	2615V	9915	6515	6515-2	DUO262	0874	0774
550/65-25	2636		9936	6536	6536-2			
555/70-25	2633		9933	6533	6533-2			
600/65-25	2642		9942	6542	6542-2			
650/65-25	2648		9948	6548	6548-2			
705/70-25	2648		9948	6548	6548-2			
750/65-25	2657		9957	6557	6557-2			
420/85-26						DUO262		
340/85-28						DUO242		
380/85-28						DUO250		
420/85-28						DUO262		
440/80-28						DUO269	0884	0784
380/85-30						DUO252		
420/90-30						DUO266		
460/80-30						DUO271		
480/80-30						DUO271		
420/85-34						DUO266		
480/85-34						DUO273		
480/80-38						DUO274		
520/85-38						DUO276		
480/80-42						DUO277		
520/85-42						DUO285		
320/90-46						DUO248		

THIS IS A GUIDE ONLY

ACTUAL FITMENT MAY

VARY AND CLEARANCES

VARY, PLEASE CHECK

LOADER - GRADER - TRACTOR



LOADER / GRADER CHAIN

REGULAR AND V-BAR

FOR PLOWS, GRADERS, FORKLIFTS, SCRAPERS, LOADERS, ETC.

[FIND PRICING IN JOBBER ON WEBSITE](#)

(Packed 1/2 Pair Per Package)

REGULAR

TIRE SIZE	Wire Size	REGULAR, V-BAR & PREMIUM TYPES				
		Stock No.	Premium Stock No.	Wt./Pr.	Cross Chain No.	Wire Size
13.00-24/25; 14.00-20/21; 15.5-25; 14.75-80R20; 44/1800R20; 445/65R19.5; 495/55R22.5; 400/70-20	10 MM	2612	A2612	108	6630 / A6630	8 MM
		2612V	A2612V	127	6830 / A6830	8 MM
14.00-24; 14.00-25; 395/85R20; 385/95R24; 17.5L-24	10 MM	2615	A2615	124	6630 / A6630	8 MM
		2615V	A2615V	158	6830 / A6830	8 MM
16.00-20/21; 17.5-25; 420/70R24	11.5 MM	2624	A2624	159	6640 / A6640	11 MM
16.00-24; 16.00-25; 19.5L-24; 17.5/65-20	11.5 MM	2627	A2627	195	6640 / A6640	11 MM
20.5-25	11.5 MM	2633	A2633	193	6650 / A6650	11 MM
18.00-25; 18.00-26; 21LX24; 555/70-25; 550/65-25	11.5 MM	2636	A2636	210	6650 / A6650	11 MM
18.00-33; 600/65-25	11.5 MM	2642	A2642	265	6650 / A6650	11 MM
23.5-25; 25.5-25; 625/70-20	13 MM	2645	A2645	362	6660 / A6660	13 MM
21.00-24; 21.00-25; 705/70R25; 650.65-25	13 MM	2648	A2648	383	6660 / A6660	13 MM
21.00-35	13 MM	2654	A2654	451	6660 / A6660	13 MM
26.5-25; 750/65-25; 755/70-25; 800/65-32; 710/70-38	13 MM	2657	A2657	448	6670 / A6670	13 MM
24.00-25; 26.5-29	13 MM	2660	A2660	472	6670 / A6670	13 MM
29.5-25	13 MM	2672	A2672	503	6680 / A6680	13 MM
29.5-29	13 MM	2675	A2675	531	6680 / A6680	13 MM
33.5-33	13 MM	2678	A2678	589	6690 / A6690	13 MM
35/65-33	13 MM	2680	A2680	610	6690 / A6690	13 MM
37.5-33	13 MM	2682	A2682	681	6692 / A6692	13 MM
24.00-35	13 MM	2686	A2686	702	6693 / A6693	13 MM
29.5-35	13 MM	2688	A2688	706	6694 / A6694	13 MM

Stock #'s beginning with an "A" are Premium

SQUARE LINK ALLOY

FOR PLOWS, GRADERS, FORKLIFTS, SCRAPERS, LOADERS, ETC.

- ALLOY STEEL CONSTRUCTION FOR MAXIMUM LIFE
- REVERSIBLE - CAN BE RUN ON BOTH SIDES
- INCREASED TRACTION
- ALSO AVAILABLE WITH SHACKLES



2 - LINK SPACING PICTURED

[FIND PRICING IN JOBBER ON WEBSITE](#)

TIRE SIZE	Wire Size	4-LINK SPACING		2-LINK SPACING		Cross Chain No.	Side Chain No.	Wire Size
		Stock No.	Wt./Pr.	Stock No.	Wt./Pr.			
13.00-24; 15.5-25; 445/45R18; 495/55R22.5** 400/70-20	10 MM	6512	140	6512-2	232	E6530S	40375	10 MM
14.00-24 SPECIAL**	8.2 MM	6514	105	6514-2	174	E6520S	40312	8 MM
14.00-24; 14.00-25; 395/85R20**; 17.5L-24	10 MM	6515	162	6515-2	274	E6530S	40375	10 MM
17.5-25; 16.00-20; 420/70R24**	11.5 MM	6524	177	6524-2	334	E6540SH	40437	11 MM
16.00-24; 16.00-25**; 19.5L-24; 17.5/65-20	11.5 MM	6527	214	6527-2	411	E6540SH	40437	11 MM
20.5-25**	11.5 MM	6533	232	6533-2	444	E6550SH	40437	11 MM
18.00-25; 18.00-26; 21LX24; 555/70-25; 550/65-25	11.5 MM	6536	252	6536-2	481	E6550SH	40437	11 MM
18.00-33; 600/65-25	11.5 MM	6542	315	6542-2	500	E6550SH	40437	11 MM
23.5-25; 25/65-25	13 MM	6545	420	6545-2	660	E6560SH	40531	13 MM
21.00-35	13 MM	6554	524	6554-2	768	E6560SH	40531	13 MM
26.5-25; 750/65-25; 755/70-25; 800/65-32; 710/70-38	13 MM	6557	438	6557-2	675	E6570SH	40531	13 MM
29.5-25	13 MM	6572	600	6572-2	1180	E6580SH	40531	13 MM
29.5-29	13 MM	6575	631	6575-2	1242	E6580SH	40531	13 MM
35/65-33	13 MM	6580	725	6580-2	1382	E6590SH	40531	13 MM

** ALSO AVAILABLE IN TWISTED SQUARE LINK — SPECIAL ORDER ITEM

PREMIUM SQUARE LINK ALLOY

MADE IN NORWAY 

FOR PLOWS, GRADERS, FORKLIFTS, SCRAPERS, LOADERS, ETC.

- ALLOY STEEL CONSTRUCTION FOR MAXIMUM LIFE
- REVERSIBLE - CAN BE RUN ON BOTH SIDES
- INCREASED TRACTION
- ALSO AVAILABLE WITH SHACKLES

0296
Adjuster
Page 78



2 - LINK SPACING PICTURED

TIRE SIZE	Wire Size	4-LINK SPACING		2-LINK SPACING		Cross Chain No.	Side Chain No.	Wire Size
		Stock No.	Wt./Pr.	Stock No.	Wt./Pr.			
13.00-24; 15.5-25; 445/45R18; 495/55R22.5; 400/70-20	10 MM	6512N	126	6512-2N	232	E6530N	40375	10 MM
14.00-24 SPECIAL	8.2 MM	6514N	105	6514-2N	174	E6520N	40312	8 MM
14.00-24; 14.00-25; 395/85R20; 17.5L-24	10 MM	6515N	162	6515-2N	274	E6530N	40375	10 MM
17.5-25; 16.00-20; 420/70R24	11.5 MM	6524N	177	6524-2N	334	E6540N	40437	11 MM
16.00-24; 16.00-25; 19.5L-24; 17.5/65-20	11.5 MM	6527N	214	6527-2N	411	E6540N	40437	11 MM
20.5-25	11.5 MM	6533N	232	6533-2N	444	E6550N	40437	11 MM
18.00-25; 18.00-26; 21LX24; 555/70-25; 550/65-25	11.5 MM	6536N	252	6536-2N	481	E6550N	40437	11 MM
18.00-33; 600/65-25	11.5 MM	6542N	306	6542-2N	500	E6550N	40437	11 MM
23.5-25; 25/65-25	13 MM	6545N	420	6545-2N	660	E6560N	40531	13 MM
21.00-35	13 MM	6554N	524	6554-2N	1028	E6560N	40531	13 MM
26.5-25; 750/65-20; 755/70-25; 800/65-32; 710/70-38	13 MM	6557N	438	6557-2N	1104	E6570N	40531	13 MM
29.5-25	13 MM	6572N	600	6572-2N	1180	E6580N	40531	13 MM
29.5-29	13 MM	6575N	631	6575-2N	1242	E6580N	40531	13 MM
35/65-33	13 MM	6580N	725	6580-2N	1382	E6590N	40531	13 MM

0296
Adjuster
Page 78

"U-GRIP" SQUARE LINK ALLOY

FOR PLOWS, GRADERS, FORKLIFTS, SCRAPERS, LOADERS, ETC.

- ALLOY STEEL CONSTRUCTION FOR MAXIMUM LIFE
- INCREASED TRACTION
- ALSO AVAILABLE WITH SHACKLES



2 - LINK SPACING PICTURED

TIRE SIZE	Wire Size	4-LINK SPACING		2-LINK SPACING		Cross Chain No.	Side Chain No.	Wire Size
		Stock No.	Wt./Pr.	Stock No.	Wt./Pr.			
13.00-24; 15.5-25; 445/45R18; 495/55R22.5 400/70-20	10 MM	6512U	126	6512U-2	232	E6530SU	40375	10 MM
14.00-24 SPECIAL	8.2 MM	6514U	105	6514U-2	174	E6520SU	40312	8 MM
14.00-24; 14.00-25; 395/85R20; 17.5L-24	10 MM	6515U	162	6515U-2	274	E6530SU	40375	10 MM
17.5-25; 16.00-20; 420/70R24	11.5 MM	6524U	177	6524U-2	334	E6540SHU	40437	11 MM
16.00-24; 16.00-25; 19.5L-24; 17.5/65-20	11.5 MM	6527U	214	6527U-2	408	E6540SHU	40437	11 MM
20.5-25	11.5 MM	6533U	232	6533U-2	444	E6550SHU	40437	11 MM
18.00-25; 18.00-26; 21LX24; 555/70-25; 550/65-25	11.5 MM	6536U	252	6536U-2	401	E6550SHU	40437	11 MM
18.00-33; 600/65-25	11.5 MM	6542U	315	6542U-2	500	E6550SHU	40437	11 MM
23.5-25; 25/65-25	13 MM	6545U	420	6545U-2	660	E6560SHU	40531	13 MM
21.00-35	13 MM	6554U	524	6554U-2	768	E6560SHU	40531	13 MM
26.5-25; 750/65-25; 755/70-25; 800/65-32; 710/70-38	13 MM	6557U	438	6557U-2	675	E6570SHU	40531	13 MM
29.5-25	13 MM	6572U	600	6572U-2	1180	E6580SHU	40531	13 MM
29.5-29	13 MM	6575U	631	6575U-2	1242	E6580SHU	40531	13 MM
35/65-33	13 MM	6580U	725	6580U-2	1382	E6590SHU	40531	13 MM

MAXTRACK

ALLOY SQUARE LINK CHAINS

GRADER / LOADER

FOR PLOWS, GRADERS, FORKLIFTS, SCRAPERS, LOADERS, ETC.

0296
Adjuster
Page 78

Link Over Link Construction



[FIND PRICING IN JOBBER ON WEBSITE](#)

TIRE SIZES		3/8" CROSS CHAIN			7/16" CROSS CHAIN		
LOADER GRADER	BACKHOE TRACTOR	Stock No.	Wt./ Pr.	Cross Chain No.	Stock No.	Wt./ Pr.	Cross Chain No.
13.00-24	13.6-28; 420/70-24; 385/85-24	8103MT	217	8901	8111MT	316	8903
14.00-24; 15.5-25	17.5-24; 16.9-24; 420/85-28; 16.9-28	8104MT	253	8902	8111MT	316	8903
16.00-24; 16.00-25	19.5-L24	8105MT	256	8902	8112MT	329	8904
18.4-28	18.4-26; 16.9-30	8106MT	259	8902	8110MT	443	8904
16.00-20; 17.5-25					8113MT	414	8904
18.00-25; 20.5-25; 550/65-25	18.4-30; 21L-24; 23.1-34; 480/85-30				8114MT	369	8905
23.5-25; 25/65/25; 2100-25; 20.8-34	23.1-26; 18.4-34; 480/85-34				8115MT	494	8906
26.5-25; 26.5-29; 24.00-25	24.5-32						8622MT
29.5-25	30.5-32; 580/85-42						8624MT
29.5-29							8626MT
							8627MT
							8628MT
							8629MT

MAXTRACK "U-GRIP"

ALLOY SQUARE LINK CHAINS

GRADER / LOADER

FOR PLOWS, GRADERS, FORKLIFTS, SCRAPERS, LOADERS, ETC.

0296
Adjuster
Page 78

U-GRIP Construction



[FIND PRICING IN JOBBER ON WEBSITE](#)

TIRE SIZES		7/16" CROSS CHAIN		
LOADER GRADER	BACKHOE TRACTOR	Stock No.	Wt./ Pr.	Cross Chain No.
13.00-24	13.6-28; 420/70-24; 385/85-24	8111MTU	316	8903U
14.00-24; 15.5-25	17.5L-24; 16.9-24; 420/85-28; 16.9-28	8111MTU	316	8903U
16.00-24; 16.00-25	19.5-L24	8112MTU	329	8904U
18.4-28	18.4-26; 16.9-30; 18.4-30	8110MTU	453	8904U
16.00-20; 17.5-25		8113MTU	358	8904U
18.00-25; 20.5-25; 550/65-25	18.4-30; 21L-24; 23.1-34; 480/80-30	8114MTU	369	8905U
23.5-25; 25/65/25; 2100-25; 20.8-34	23.1-26; 18.4-34; 480/85-34	8115MTU	502	8906U
26.5-25; 26.5-29; 24.00-25	24.5-32			8622MTU
29.5-25	30.5-32; 580/85-42			8624MTU
29.5-29				8626MTU
				8627MTU
				8628MTU
				8629MTU

DIAMOND BACK ALLOY SQUARE LINK

LOADER / GRADER

DIAMOND PATTERN (DP)

DIAMOND PATTERN **U-GRIP** (DPU)

WEAR-EVER DIAMOND PATTERN (WDP) LINK OVER LINK

WEAR-EVER DIAMOND PATTERN WITH WEAR BAR (WB)
AND LINK OVER LINK DESIGN

PULL CHAIN TIGHTENING SYSTEM

[FIND PRICING IN JOBBER ON WEBSITE](#)



U-GRIP PICTURED



(DP)

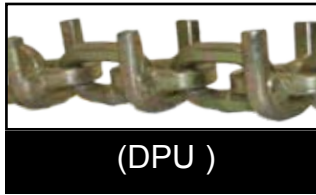

(DPU)

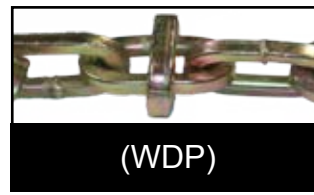

(WDP)

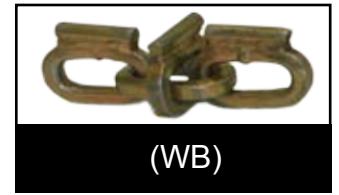

(WB)

**NOW AVAILABLE IN U-GRIP
(DPU)**

8 MM 5/16"

TIRE SIZE	DP Stock Number	Wt./Pr.	DPU Stock Number	Wt./Pr.	WDP Stock Number	Wt./Pr.	WB Stock Number	Wt./Pr.
14.00X24; 15.5-25; 17.5L-24; 16.9-24					2715WDP-8	189	2715WB-8	217
16.00X24; 16.00-25; 19.5L-24					2727WDP-8	201	2727WB-8	231

10 MM 3/8"

14.00X24; 15.5-25; 17.5L-24; 16.9-24	2715DP-10	224	2715DPU-10	268	2715WDP-10	268	2715WB-10	286
16.00X24; 16.00-25; 19.5L-24	2727DP-10	242	2727DPU-10	285	2727WDP-10	285	2727WB-10	303
17.5X25; 16.00-20	2724DP-10	220	2724DPU-10	264	2724WDP-10	264	2724WB-10	322
20.5X25; 18.00-25; 18.4-30; 21L-24	2733DP-10	258	2733DPU-10	275	2733WDP-10	318	2733WB-10	384

11.5 MM 7/16"

14.00X24; 15.5-25; 17.5L-24; 16.9-24	2715DP-11	338	2715DPU-11	388	2715WDP-11	388	2715WB-11	400
16.00X24; 16.00-25; 19.5L-24	2727DP-11	358	2727DPU-11	420	2727WDP-11	420	2727WB-11	429
17.5X25; 16.00-20	2724DP-11	332	2724DPU-11	392	2724WDP-11	392	2724WB-11	460
20.5X25; 18.00-25; 18.4-30; 21L-24	2733DP-11	392	2733DPU-11	472	2733WDP-11	472	2733WB-11	470
23.5X25; 21.00-25; 20.8-34; 25/65-25	2745DP-11	436	2745DPU-11	532	2745WDP-11	532	2745WB-11	630

13 MM 1/2"

17.5X25; 16.00-20	2724DP-13	502	2724DPU-13	502	2724WDP-13	502	2724WB-13	721
20.5X25; 18.00-25; 18.4-30; 21L-24	2733DP-13	474	2733DPU-13	559	2733WDP-13	559	2733WB-13	785
23.5X25; 21.00-25; 20.8-34; 25/65-25	2745DP-13	532	2745DPU-13	636	2745WDP-13	636	2745WB-13	867
26.5X25; 26.5X29; 24.00-25; 24.5X32			2757DPU-13	676	2757WDP-13	676	2757WB-13	922
29.5X25; 30.5X32			2772DPU-13	871	2772WDP-13	871	2772WB-13	1263

MEGATRAC ALLOY

REGULAR TWIST AND IN THE NEW **U-GRIP** DESIGN. THE PERFECT CHAIN FOR A FARM TRACTOR, LOADER OR BACKHOE

CALL FOR TRACTOR SIZES



U-GRIP

FIND PRICING IN JOBBER ON WEBSITE

Megatrac **U-GRIP** Loader Standard Duty Sizes

TIRE SIZE	Stock Number	Wt./Pr.	Wire Dia.	Stock Number	Wt./Pr.	Wire Dia.
13.00X24	2712U-11	336	11.5 MM			
14.00X24; 15.5-25	2715U-11	388	11.5 MM			
16.00X24; 16.00-25	2727U-11	420	11.5 MM			
17.5X25; 16.00-20	2724U-11	392	11.5 MM			
21L24	2736U-11	524	11.5 MM			
20.5X25; 18.00-25; 18.4-30; 23.1-34				2733U-13	559	13 MM
23.5X25; 21.00-25; 20.8-34; 25/65-25				2745U-13	636	13 MM

Megatrac **U-GRIP** Loader **HEAVY DUTY** Sizes

TIRE SIZE	Stock Number	Wt./Pr.	Wire Dia.
26.5X25; 26.5X29; 24.00-25; 24.5X32	2757U-14	876	14 MM
29.5X25; 30.5X32	2772U-14	1071	14 MM
29.5X29	2775U-14	1192	14 MM



Megatrac Loader Standard Duty Sizes **REGULAR TWIST**

TIRE SIZE	Stock Number	Wt./Pr.	Wire Dia.
13.00X24	2712-10	255	10 MM
14.00X24; 15.5-25	2715-10	268	10 MM

Megatrac Backhoe Standard Duty Sizes

TIRE SIZE	Stock Number	Wt./Pr.	Wire Dia.
14.9X24	2712-10	255	10 MM
16.9X24	2715-10	268	10 MM
17.5L-24	2715-10	268	10 MM
18.4X24	2724-10	264	10 MM
18.4X26	2724-10	264	10 MM
19.5L-24	2724-10	264	10 MM
21LX24	2736-10	419	10 MM

DRQ & WBQ MADE IN EUROPE

- Diamond Pattern High Alloy chain for snow removal use on loaders and graders



DRQ—WITHOUT WEAR BARS
 WBQ—WITH WEAR BARS
 PULL CHAIN TIGHTENING SYSTEM

[FIND PRICING IN JOBBER ON WEBSITE](#)

DRQ—WITHOUT “WEAR BAR”

Tire Size	Part #	Wire Diameter	Wt./Pair
14.00X24	538DRQ	8 MM	232
14.00X24	540DRQ	10 MM	362
17.5X25	580DRQ	10 MM	396
20.5X25	592DRQ	11 MM	582
23.5X25	602DRQ	11 MM	624

WBQ With “WEAR-BAR”

Tire Size	Part #	Wire Diameter	Wt./Pair
14.00X24	540WBQ	10 MM	372
16.00X24	560WBQ	10 MM	376
17.5X25	580WBQ	10 MM	378
20.5X25	590WBQ	10 MM	279
20.5X25	592WBQ	11 MM	436
23.5X25	600WBQ	10 MM	477
23.5X25	602WBQ	11 MM	701
23.5X25	613WBQ	13 MM	850

DRSQ & WBSQ MADE IN EUROPE

- Double—Diamond High Alloy chain for snow removal use on loaders and graders



DRSQ—Without Wear Bars
 WBSQ—With Wear Bars
 PULL CHAIN TIGHTENING SYSTEM

[FIND PRICING IN JOBBER ON WEBSITE](#)

Tire Size	Part # Without Wear Bar	Wire Dia.	Wt. Pr.	Part # With Wear Bar	Wt. Pr.
14.00X24	540DRSQ	10 MM	398	540WBSQ	419
17.5X25	580DRSQ	10 MM	432	580WBSQ	450
20.5X25	590DRSQ	10 MM	488	590WBSQ	514
20.5X25	592DRSQ	11 MM	556		
23.5X25	600DRSQ	10 MM	584	600WBSQ	600
23.5X25	602DRSQ	11 MM	616		
26.5X25	620DRSQ	11 MM	741		

 LOADER - GRADER - TRACTOR

FIELDMASTER

TRACTION CHAINS

ROUND LINK TWISTED LADDER STYLE
CHAINS PROVIDE EXCELLENT TRACTION
FOR TRACTORS & BACKHOES

**NOT INTENDED FOR LOADER /
GRADER USE**

(Packed 1/2 Pair Per Bag)

FIND PRICING IN JOBBER ON WEBSITE



FIELDMASTER

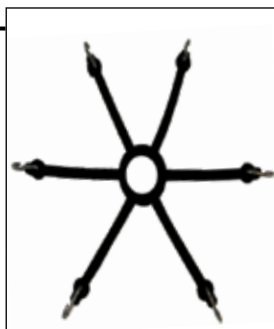

0220 HD SPIDER BUNGEE

SPIDER
BUNGEE
DOES NOT
FIT ALL
SIZES.
CALL FOR
CORRECT
ADJUSTER.

0220
0294
0296

TIRE SIZE	Wire Diameter	Stock No.		Wt./Pr.	Cross Chain No.
8.3X16	7 MM	3227	A3227	34	6253 / A6253
8.3-24; 9.5-18; 1100-16	10 MM	0822	A0822	72	6434 / A6434
9.5-16	10 MM	0829	A0829	61	6434 / A6434
9.5-24; 10.5X80X18; 300/70-20; 230/90-32	10 MM	0832	A0832	76	6434 / A6434
12.5X80X18; 335/80-18	10 MM	0834	A0834	89	6445 / A6445
9.5-28; 12.4X16; 360/70-20; 380/70-20; 340/80R18; 355/80-20	10 MM	0836	A0836	83	6445 / A6445
11.2-28; 9.5-32; 13.5-16.1; 11.2X24; 320/85-24	10 MM	0838	A0838	103	6445 / A6445
11.2-34; 11.2-36	10 MM	0846	A0846	121	6445 / A6445
13.6-16	10 MM	0850	A0850	84	7420 / A7420
12.4-24; 15-22.5; 320/70-24	10 MM	0852	A0852	101	6445 / A6445
12.4-28; 230/95-36	10 MM	0856	A0856	106	6445 / A6445
13.6X24; 13.6X26; 400/70-20; 380/70-24; 41X14-20; 405/70-20; 44X18-20	10 MM	0858	A0858	115	7420 / A7420
13.6-28; 14.9-24; 420/70-24	10 MM	0859	A0859	117	7420 / A7420
11.2-38; 12.4-36; 12.4-38	10 MM	0862	A0862	96	6445 / A6445
13.6-38; 13.6-36; 13.9-36	10 MM	0866	A0866	146	7420 / A7420
14.9-26; 14.9-28	10 MM	0869	A0869	132	7420 / A7420
14.9-38	10 MM	0871	A0871	154	7420 / A7420
16.9-24; 17.5L-24; 460/70-24	10 MM	0874	A0874	134	7426 / A7426
16.9X26; 16.9X28; 14.9X30; 380/85-30; 420/85-28	10 MM	0876	A0876	150	7426 / A7426
16.9-30; 16.9-32	10 MM	0877	A0877	155	7426 / A7426
16.9-34; 15.5-38	10 MM	0879	A0879	153	7426 / A7426
16.9-38	10 MM	0880	A0880	181	7426 / A7426
18.4-16.1**	11 MM	0881	A0881	134	9562 / A9562
21.5-16; 21.5L-16.1	11 MM	0882	A0882	161	9562 / A9562
18.4-24; 19.5L-24; 18.4-26	11 MM	0883	A0883	177	9562 / A9562
18.4-28; 440/80R28; 550/65-26	11 MM	0884	A0884	187	9562 / A9562
18.4-30; 21L-24	11 MM	0885	A0885	180	9562 / A9562
18.4-34; 480/85-34; 600/65-25	11 MM	0887	A0887	213	9562 / A9562
18.4-38; 480/80-38	11 MM	0889	A0889	240	9562 / A9562
20.8-34	13 MM	0890	A0890	289	6650 / A6650
23.1-26	11 MM	0891	A0891	223	9567 / A9567
20.8-38; 520/85-38	13 MM	0892	A0892	256	6650 / A6650
23.1-30; 480/80-42	11 MM	0893	A0893	253	9567 / A9567
18.4-42; 420/80-46	11 MM	0894	A0894	245	9562 / A9562
23.1-34	11 MM	0895	A0895	345	9567 / A9567

****Two very different tires in this size. Double check measurements**

Stock #'s beginning with an "A" are Premium

DUO GRIP

TRACTOR CHAINS

(Packed 1/2 Pair Per Bag)

- BEST OVERALL TRACTION , LESS SIDE SLIP
- H-PATTERN KEEPS CHAIN OUT OF LUGS

NOT INTENDED FOR LOADER / GRADER USE

CALL FOR
CORRECT
ADJUSTER
0220
0294
0296



FIND PRICING IN JOBBER ON WEBSITE

3/8" (10 MM)

TIRE SIZE	Stock No.		Wt./Pr.	Cross Chain No.
12.5X80-18; 335/80-18	DUO210	ADUO210	101	DUO293 / ADUO293
9.5-28; 13.5-16.1; 9.5-24; 11.2-16; 300/70-20; 360/70-20; 380/70-20	DUO214	ADUO214	105	DUO292 / ADUO292
11.2-32; 12.4-28; 10-32; 11-28	DUO218	ADUO218	125	DUO293 / ADUO293
11.2-34; 11.2-36	DUO224	ADUO224	154	DUO292 / ADUO292
9.5-32; 11.2-28; 11.2-24; 230/95-32; 320/85-24; 355/80-20	DUO226	ADUO226	127	DUO292 / ADUO292
9.5R44	DUO227	ADUO227	176	DUO292 / ADUO292
8.3R44; 9.50R40	DUO228	ADUO228	155	DUO292 / ADUO292
12.4-16; 12.4-24; 320/70-24	DUO229	ADUO229	138	DUO293 / ADUO293
11.2-38; 12.4-36; 12.4-38; 10-38; 11-38; 11-36; 270/95-44; 320/85-38; 320/85-34	DUO232	ADUO232	183	DUO293 / ADUO293
11.2R44; 9.5R48	DUO236	ADUO236	203	DUO293 / ADUO293
43X16-20; 15X19.5	DUO239	ADUO239	135	DUO295 / ADUO295
13.6-24; 13.6-26; 41X14-20; 400/70-20; 405/70-20; 380/70-24	DUO240	ADUO240	150	DUO295 / ADUO295
13.6-28; 14.9-24; 12-28; 13.00-24; 420/70-24; 380/85-34; 340/85-28	DUO242	ADUO242	141	DUO294 / ADUO294
12.4-40; 12.4-42; 13.6-36; 13.6-38; 13.9-36; 12-36; 320/85-34	DUO246	ADUO246	191	DUO294 / ADUO294
11.2R48	DUO247	ADUO247	197	DUO294 / ADUO294
12.4R46	DUO248	ADUO248	270	DUO297 / ADUO297
14.9-26; 14.9-28; 380/85-28; 420/70-24; 420/70-26	DUO250	ADUO250	144	DUO295 / ADUO295
14.9-30; 380/85-30	DUO252	ADUO252	182	DUO295 / ADUO295
14.9-38; 320/90-46	DUO254	ADUO254	178	DUO296 / ADUO296
14.9R46; 380/90-46	DUO256	ADUO256	237	DUO297 / ADUO297
12.4R52; 12.4-48	DUO259	ADUO259	254	DUO297 / ADUO297
12.4R54	DUO261	ADUO261	270	DUO297 / ADUO297
16.9-24; 16.9-26; 16.9-28; 14.00-24; 17.5L-24; 420/85-28; 425/85-24; 460/70-24	DUO262	ADUO262	147	DUO297 / ADUO297
18.4-16.1; 40X19X19.5	DUO264	ADUO264	142	DUO298 / ADUO298
16.9-30; 16.9-32; 420/90-30; 420/85-34	DUO266	ADUO266	170	DUO297 / ADUO297
18.4-26; 19.5L-24; 18.4-24; 17.5-25	DUO268	ADUO268	160	DUO298 / ADUO298
18.4-28; 440/80R28	DUO269	ADUO269	177	DUO298 / ADUO298
15.5-38; 16.9-34	DUO270	ADUO270	180	DUO297 / ADUO297
18.4-30; 21L-24; 550/65-25; 540/65-30; 600/65-28	DUO271	ADUO271	175	DUO298 / ADUO298
16.9-38; 20.8-34; 380/90-50; 480/80-46; 460/85-34	DUO272	ADUO272	192	DUO298 / ADUO298
18.4-34; 480/85-34; 600/65-26	DUO273	ADUO273	173	DUO298 / ADUO298
18.4-38; 480/80-38	DUO274	ADUO274	242	DUO298 / ADUO298
20.8-38; 520/85-38	DUO276	ADUO276	274	DUO299 / ADUO299
18.4R46; 18.4-42; 480/80R20; 480/80-42; 480/80-46; 380/90-54	DUO277	ADUO277	263	DUO298 / ADUO298
24.5-32	DUO278	ADUO278	253	DUO301 / ADUO301
23.1-26; 23.1-28	DUO280	ADUO280	211	DUO299 / ADUO299
23.1-30	DUO281	ADUO281	239	DUO299 / ADUO299
23.1-34; 20.8-34; 650/75-32	DUO282	ADUO282	261	DUO299 / ADUO299
30.5L-32; 520/85-42	DUO283	ADUO283	304	DUO301 / ADUO301
20.8-42	DUO285	ADUO285	298	DUO301 / ADUO301

Stock #'s beginning with an "A" are Premium

Optional Spider
Bungee
Part # 0213
Sold Separately

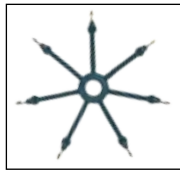

SNOW BLOWERS AND GARDEN TRACTOR CHAINS

(Packed 1 Pair Per Bag) [FIND PRICING IN JOBBER ON WEBSITE](#)

ASK ABOUT ANY SIZE NOT LISTED; 4 LINK SPACING AVAILABLE

2 LINK SPACING

TIRE SIZE	2 LINK SPACING		HEAVY DUTY 2 LINK SPACING	
	Stock No.	Wt./Pr.	Stock No.	Wt./Pr.
4.00/4.80X8; 13X6.5X6; 14X4X6; 4.80X12; 13X4X6; 10X6X6	1301	12	1301HD	15
18X8.50X8; 16X7.50X8	1302	14	1302HD	26
23X9.50X12; 23X10.50X12; 20X10X10; 20X10X8; 21X8X10; 20X9X10; 22X10X8; 24X8.50X12	1303	16	1303HD	29
8X12; 23X8.50X12; 7.00X12; 22X7X12; 24X9X12; 23X6.50X12	1304	15	1304HD	29
10/10.5X2.75; 10.25X3.25; 10X3.50	1306	5	1306HD	28
27X8.50X15; 25X8.50X14; 8X15; 7X16	1307	28	1307HD	45
20X8.00X10; 22X10.00-10; 20X8X8; 20X7X12; 20X9X8; 21X7X10	1308	14	1308HD	16
4.10/3.50X4; 3.40/3.00X5	1309	6	1309HD	22
6X12; 23X7.50X12	1311	14	1311HD	34
16X6.50X8; 18X6.50X8	1312	13	1312HD	15
28X8X16	1313	20	1313HD	26
1.45X70X6; 15X5.00X6; 15X6.00X6; 5.30X6; 5.30X4.50X6; 15X6.50X8	1314	10	1314HD	16
26X12.00X12; 25X10X8; 24X10.50X12; 26X10X12; 26X11X12	1316	25	1316HD	32
4.10/4.50X5; 4.10/3.50X6; 12X3.50X6; 12.25X3.50X6	1317	4	1317HD	6
27X12X12	1318	30	1318HD	39
24X12X12	1319	25	1319HD	33
13X5X6; 12.5X4.50X6; 12X7X4; 13X4X5; 10X6X6; 13X5.00X7; 13X4X6; 13X4.1	1321	6	1321HD	8
5.00/5.70X8	1322	16	1322HD	20
18X9.50X8; 18X8.50X10	1323	16	1323HD	20

H-PATTERN CHAIN FOR SNOW BLOWERS AND GARDEN TRACTORS

AVAILABLE IN REGULAR AND V-BAR STYLE

REGULAR (5 MM) & HEAVY DUTY (7 MM)

(Packed 1 Pair Per Bag)

Optional Spider
Bungee
Part # 0213
Sold Separately



[FIND PRICING IN JOBBER ON WEBSITE](#)

TIRE SIZE	STANDARD LINK				V-BAR			
	REGULAR		HEAVY DUTY		REGULAR		HEAVY DUTY	
	5 MM Stock No.	Wt./Pr.	7 MM Stock No.	Wt./Pr.	5 MM Stock No.	Wt./Pr.	7 MM Stock No.	Wt./Pr.
18X8.50X8	HP1302	22	HP1302HD	25	HP1302V	25	HP1302HDV	29
23X9.50X12; 23X10.50X12; 20X10X10	HP1303	38	HP1303HD	42	HP1303V	40	HP1303HDV	47
8X12; 23X8.50X12; 7.00X12	HP1304	26	HP1304HD	30	HP1304V	32	HP1304HDV	36
27X8.50X15; 25X8.50X14; 8X15; 7X16	HP1307	47	HP1307HD	52	HP1307V	49	HP1307HDV	51
20X8.00X10; 22X10.00-10	HP1308	25	HP1308HD	30	HP1308V	28	HP1308HDV	33
6X12; 23X7.50X12	HP1311	28	HP1311HD	32	HP1311V	31	HP1311HDV	35
16X6.50X8	HP1312	21	HP1312HD	24	HP1312V	23	HP1312HDV	26
28X8X16	HP1313	34	HP1313HD	37	HP1313V	36	HP1313HDV	41
26X12.00X12	HP1316	42	HP1316HD	46	HP1316V	44	HP1316HDV	58
8.3X16			HP1317HD	43			HP1317HDV	51
8.3-24; 9.5-18; 11.00-16			HP1318HD	66			HP1318HDV	75
9.5-16			HP1319HD	59			HP1319HDV	63
9.5-24; 10.5/80-18			HP1320HD	61			HP1320HDV	65

INDUSTRIAL FORKLIFT TIRE CHAINS

Round Twist Carbon Chain For Improved Traction On Forklifts

Available in 2 LINK & 4 LINK SPACING



(Packed 1 Pair Per Bag)

[FIND PRICING IN JOBBER ON WEBSITE](#)



2 LINK SPACING

TIRE SIZE	2 LINK SPACING			4 LINK SPACING		
	Stock No.	Wt./Pr.	Cross Chain No.	Stock No.	Wt./Pr.	Cross Chain No.
6.5X10; 21X8X9	1401-2	44	6250	1401-4	26	6250
7.00X12; 28X9X15; 29X8X15	1403-2	48	6255	1403-4	32	6255
7.00X15; 28X8X15	1404-2	56	6256	1404-4	36	6256
7.50X15; 20X15	1405-2	59	6256	1405-4	35	6256
8.15X15; 23X10X12	1407-2	66	6260	1407-4	39	6260
8.25X15; 2.50X15	1408-2	78	6256	1408-4	54	6256
7.50X16; 30X8X15; 28X12X15	1409-2	55	6254	1409-4	33	6254

INDUSTRIAL FORKLIFT TIRE CHAINS SQUARE LINK ALLOY

Square Link Alloy Chain For Improved Traction And Long Life On Forklifts

Available in 2 LINK & 4 LINK SPACING



(Packed 1 Pair Per Bag)

[FIND PRICING IN JOBBER ON WEBSITE](#)



2 LINK SPACING

TIRE SIZE	2 LINK SPACING			4 LINK SPACING		
	Stock No.	Wt./Pr.	Cross Chain No.	Stock No.	Wt./Pr.	Cross Chain No.
6.5X10; 21X8X9	1401-2SL	57	6250SL	1401-4SL	26	6250SL
7.00X12; 28X9X15; 29X8X15	1403-2SL	60	6255SL	1403-4SL	36	6255SL
7.00X15; 28X8X15	1404-2SL	56	6256SL	1404-4SL	38	6256SL
7.50X15; 20X15	1405-2SL	71	6256SL	1405-4SL	36	6256SL
8.15X15; 23X10X12	1407-2SL	82	6260SL	1407-4SL	56	6260SL
8.25X15; 2.50X15	1408-2SL	78	6256SL	1408-4SL	53	6256SL
7.50X16; 30X8X15; 28X12X15	1409-2SL	65	6254SL	1409-4SL	38	6254SL

INDUSTRIAL FORKLIFT TIRE CHAINS UNIVERSAL CABLE CHAINS

CABLE CHAINS FOR FORKLIFTS THAT COME IN TWO WIDTHS (12" & 15")

CUT THE LENGTH TO CUSTOM FIT YOUR TIRE

FOR FORKLIFTS THAT HAVE LIMITED CLEARANCE

2 LINK SPACING FOR SMOOTH RIDE

RUBBER SPIDER BUNGEEES & 8" CUTTER INCLUDED

(Packed 1 Pair Per Bag)

[FIND PRICING IN JOBBER ON WEBSITE](#)

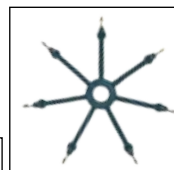

Part # 0213



2 LINK SPACING

STOCK #	WIDTH	WT./PR.	CROSS CHAIN	LENGTH	CAN SHORTEN TO:
1400-12	12"	12.5	8860	84"	44"
1400-15	15"	17	8862	96"	51"

SKID STEER TIRE CHAIN REGULAR

ROUND TWISTED LINK CARBON CHAIN

LADDER STYLE AVAILABLE IN 4 LINK SPACING AND 2 LINK SPACING
GREAT TRACTION FOR SKID STEERS.

FIND PRICING IN JOBBER ON WEBSITE

(Packed 1 Pair Per Bag)



2 LINK SPACING

TIRE SIZE	2 LINK SPACING		4 LINK SPACING		Cross Chain No.	Wire Diameter
	Stock No.	Wt./Pr.	Stock No.	Wt./Pr.		
27X10.50-15	1500-2	67	1500	40	6260	8 MM 5/16"
10X16.5	1501-2	73	1501	46	6260	8 MM 5/16"
32X10X20	1506-2	78	1506	48	6260	8 MM 5/16"
12X16.5; 31X13-16.5 31X15.5-15; 36X13.5-15 33X15.5-16.5	1502-2	85	1502	51	6268	8 MM 5/16"
14X17.5	1503-2	112	1503	58	6268	8 MM 5/16"
405/70-20	1504-2	120	1504	61	6268	8 MM 5/16"

SKID STEER TIRE CHAIN SQUARE LINK

SQUARE LINK ALLOY CHAIN FOR LONGER LIFE AND BETTER TRACTION

LADDER STYLE AVAILABLE IN 4 LINK SPACING AND 2 LINK SPACING

FIND PRICING IN JOBBER ON WEBSITE

(Packed 1 Pair Per Bag)



2 LINK SPACING

TIRE SIZE	2 LINK SPACING		4 LINK SPACING		Cross Chain No.	Wire Diameter
	Stock No.	Wt./Pr.	Stock No.	Wt./Pr.		
27X10.50-15	1500HDSL-2	77	1500HDSL	50	6260SL	8 MM 5/16"
10X16.5	1501HDSL-2	83	1501HDSL	53	6260SL	8 MM 5/16"
32X10X20	1506HDSL-2	87	1506HDSL	57	6260SL	8 MM 5/16"
12X16.5; 31X13-16.5 31X15.5-15; 36X13.5-15 33X15.5-16.5	1502HDSL-2	90	1502HDSL	62	6268SL	8 MM 5/16"
14X17.5	1503HDSL-2	108	1503HDSL	66	6268SL	8 MM 5/16"
405/70-20	1504HDSL-2	116	1504HDSL	74	6268SL	8 MM 5/16"

SKID STEER TIRE CHAIN STUDDED

STUDDED ALLOY LINK CHAIN FOR THE MOST AGGRESSIVE TRACTION

AVAILABLE IN 4 LINK SPACING AND 2 LINK SPACING

FIND PRICING IN JOBBER ON WEBSITE

(Packed 1 Pair Per Bag)



2 LINK SPACING

TIRE SIZE	2 LINK SPACING		4 LINK SPACING		Cross Chain No.	Wire Diameter
	Stock No.	Wt./Pr.	Stock No.	Wt./Pr.		
27X10.50-15	1500STUDDED-2	79	1500STUDDED	51	6923	8 MM 5/16"
10X16.5	1501STUDDED-2	83	1501STUDDED	53	6923	8 MM 5/16"
32X10X20	1506STUDDED-2	89	1506STUDDED	58	6923	8 MM 5/16"
12X16.5; 31X13-16.5 31X15.5-15; 36X13.5-15 33X15.5-16.5	1502STUDDED-2	90	1502STUDDED	62	6926	8 MM 5/16"
14X17.5	1503STUDDED-2	108	1503STUDDED	66	6926	8 MM 5/16"
405/70-20	1504STUDDED-2	118	1504STUDDED	76	6926	8 MM 5/16"

ATV - ALL TERRAIN VEHICLE TIRE CHAIN

(Packed 1 Pair Per Bag)

ATV-A, ATV-B & ATV-C ARE **V-BAR LADDER STYLE**

(AVAILABLE IN 4 LINK & 2 LINK SPACING)

ATV-DBA THROUGH ATV-DBE ARE

U-GRIP DIAMOND BACK STYLE

FIND PRICING IN JOBBER ON WEBSITE



Optional Spider Bungee
Part # 0213
Sold Separately

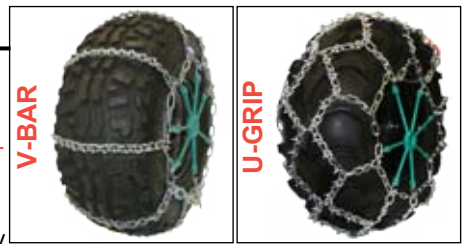

TIRE SIZE	LADDER STYLE	DIAMOND BACK	TIRE SIZE	LADDER STYLE	DIAMOND BACK
21X10X8	ATV-A	ATV-DBA	24X12X12	ATV-C	
22X9X8	ATV-A		25X8X12	ATV-B	ATV-DBA
22X10X8	ATV-A		25X10X12	ATV-C	ATV-DBB
22X11X8	ATV-A		25X11X12	ATV-C	ATV-DBB
20X10X9	ATV-A		25X12.5X12		ATV-DBC
22X10X9	ATV-A		26X8X12		ATV-DBA
22X11X9	ATV-A	ATV-DBA	26X9X12		ATV-DBD
24X11X9	ATV-C	ATV-DBB	26X10X12	ATV-C	ATV-DBD
24X13X9	ATV-C		26X10.5X12	ATV-C	ATV-DBD
25X11X9	ATV-B	ATV-DBB	26X11X12	ATV-C	ATV-DBC
25X12X9	ATV-C		26X12X12		ATV-DBD
22X7X10	ATV-A		27X9X12		ATV-DBD
22X9X10	ATV-A		27X11X12		ATV-DBC
22X10X10	ATV-A		28X10X12		ATV-DBD
23X8X10	ATV-A	ATV-DBA	185/88R12		ATV-DBA
23X10X10	ATV-A	ATV-DBA	205/80R12	ATV-C	ATV-DBA
22X11X10	ATV-B	ATV-DBA	270/60R12		ATV-DBB
23X11X10	ATV-C		26X8X14		ATV-DBE
24X11X10	ATV-C	ATV-DBB			
24X11.5X10	ATV-C	ATV-DBB			
25X10X10	ATV-C	ATV-DBB			
25X11X10	ATV-C	ATV-DBB			
25X12X10	ATV-C				
255/60R10		ATV-DBA			
280/65R10		ATV-DBD			
23X8X11	ATV-A	ATV-DBA			
24X8X11	ATV-A	ATV-DBA			
24X9X11	ATV-B	ATV-DBA			
24X10X11	ATV-C				
25X10X11	ATV-C	ATV-DBB			
15X10X12	ATV-C				
23X8.5X12		ATV-DBA			
23X10X12	ATV-A	ATV-DBA			
23X10.5X12		ATV-DBA			
24X9X12	ATV-B	ATV-DBA			
24X10X12	ATV-C				
24X11X12	ATV-B	ATV-DBB			

THIS FIT CHART IS A GUIDE ONLY. ACTUAL FITMENTS MAY VARY AND CLEARANCES MAY VARY, PLEASE CHECK. CHAINS MAY NEED SLIGHT MODIFICATIONS TO FIT SPECIFIC TIRES.

FORKLIFT - SMALL TRACTOR - SKID STEER - ATV

FORESTRY CHAINS



**RING ALLOY
OR CARBON**



**TIGHT
RING ALLOY**



**MULTI
RING ALLOY**



**STUDED
NET ALLOY**



**U-GRIP
NET ALLOY**

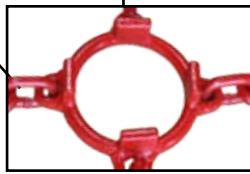

9/16" (14 MM)

FIND PRICING IN JOBBER ON WEBSITE

TIRE SIZE	RING CARBON		RING ALLOY		TIGHT RING ALLOY		MULTI RING ALLOY		STUDED NET ALLOY		U-GRIP NET ALLOY	
	STOCK NUMBER	WT/ PR	STOCK NUMBER	WT/ PR	STOCK NUMBER	WT/ PR	STOCK NUMBER	WT/ PR	STOCK NUMBER	WT/ PR	STOCK NUMBER	WT/ PR
18.4-26; 16.9-30	RC184-14	540	RA184-14	530								
23.1-26; 18.4-34	RC231-14	634	RA231-14	620								

5/8" (16 MM)

23.1-26; 18.4-34	RC231-16	676	RA231-16	668	RAT231-16	698	RAM231-16	735	NC231-16	963	NCU231-16	985
7.00X50X26.5									NC700-16	815	NCU700-16	851
6.00X55X34									NC600-16	864	NCU600-16	894
7.00X55X34									NC734-16	1185	NCU734-16	1210
28L-26; 24.5-32	RC245-16	796	RA245-16	804	RAT245-16	842	RAM245-16	902	NC245-16	1023	NCU245-16	1061
30.5-32	RC305-16	906	RA305-16	932	RAT305-16	981	RAM305-16	1109	NC305-16	1115	NCU305-16	1172
35.5-32	RC355-16	1123	RA355-16	1134	RAT355-16	1164	RAM355-16	1212				
73X44X32												

1 1/16" (18 MM)

28L-26; 24.5-32									NC245-18	1287	NCU245-18	1307
30.5-32									NC305-18	1460	NCU305-18	1490
35.5-32									NC355-18	1860	NCU355-18	1894

3/4" (19 MM)

23.1-26; 18.4-34			RA231-19	974	RAT231-19	974						
7.00X50X26.5					RAT700-19	698						
6.00X55X34					RAT600-19	698						
7.00X55X34					RAT734-19	698						
28L-26; 24.5-32			RA245-19	1044	RAT245-19	1150	RAM245-19	1215				
30.5-32			RA305-19	1210	RAT305-19	1238	RAM305-19	1298				
35.5-32			RA355-19	1420	RAT355-19	1343	RAM355-19	1404				
73X44X32					RAT730-19	1461	RAM730-19	1523				

1 3/16" (20 MM)

28L-26; 24.5-32									NC245-20	1487	NCU245-20	1517
30.5-32									NC305-20	1630	NCU305-20	1696
35.5-32									NC355-20	1984	NCU355-20	2013

1" (25 MM)

30.5-32					RAT305-25	1746	RAM305-25	1860				
35.5-32					RAT355-25	1819	RAM355-25	1915	NC355-25	2562		
73X44X32							RAM730-25	1988				

SOME NET STYLE SIZES ARE AVAILABLE IN NON-STUDED

FORESTRY CHAINS

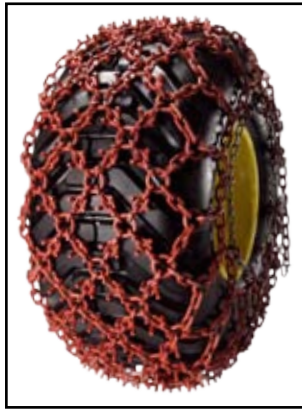

**TRIPLE DIAMOND
U-GRIP NET**



U-GRIP

TIGHTENING TOOL FOR TIGHTENING ANY CHAIN

Stock No.	Description	Wt./EA.
2505	Skidder Chain Mounting Tool	11lbs.
2507	Skidder Tightening Tool - A Type	9lbs
2505-O-RING	Replacement "O" Ring	1lbs

ADJUSTER

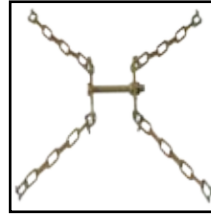

0296

TIGHTENERS

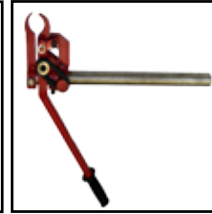

2505



2507

5/8" (16 MM) [FIND PRICING IN JOBBER ON WEBSITE](#)

TIRE SIZE	TRIPLE DIAMOND U-GRIP NET	
	STOCK NUMBER	WT/PR
30.5X32	NCUT305-16	1449
35.5X32	NCUT355-16	1609
73X44X32	NCUT730-16	1719



**STUDDED
NET**



STUDDED



**U-GRIP
NET**

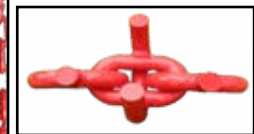

U-GRIP

NORSE

MADE IN NORWAY



5/8" (16 MM) [FIND PRICING IN JOBBER ON WEBSITE](#)

TIRE SIZE	STUDDED ALLOY		U-GRIP ALLOY	
	STOCK NUMBER	WT/PR	STOCK NUMBER	WT/PR
23.1-26; 18.4-34	NN231-16	963	NNU231-16	1040
7.00X50X26.5	NN700-16	1122	NNU700-16	1084
7.00X55X34	NN734-16	2006	NNU734-16	1356
28L-26; 24.5-32	NN245-16	1023	NNU245-16	1152
30.5-32	NN305-16	1117	NNU305-16	1238
35.5-32	NN355-16	1736	NNU355-16	1785

3/4" (19 MM)

28L-26; 24.5-32	NN245-19	1273	NNU245-19	1308
30.5-32	NN305-19	1466	NNU305-19	1785
35.5-32	NN355-19	1860	NNU355-19	1812

NEW AND IMPROVED

QUICK TRAK

Limited Clearance Traction Alternative

Made in Italy



TRACTION ALTERNATIVE FOR VEHICLES THAT HAVE NO CLEARANCE FOR TIRE CHAINS OR CABLES

Easy On , Easy Off

FIND PRICING IN JOBBER ON WEBSITE



NEW
Quick Trak Sport (3mm)
Also Available



SPIKES-SPIDER

MADE IN SWITZERLAND



- THE TRACTION ALTERNATIVE FOR VEHICLES THAT HAVE NO CLEARANCE FOR TIRE CHAINS OR CABLES
- MADE FROM SPECIAL HIGH IMPACT POLYMER
- EASY ON, EASY OFF
- STUD IMPREGNATED FOR DURABILITY
- REPLACEABLE TRACTION ARMS

FIND PRICING IN JOBBER ON WEBSITE

SPIKES SPIDER-COMPACT



PASSENGER CAR
2 Ton Vehicle Weight Limit

SPIKES SPIDER-SPORT



LIGHT TRUCK & SUV
4 Ton Vehicle Weight Limit

VISIT WWW.QUALITYCHAINCORP.COM FOR QUICK TRAK / SPIKES-SPIDER FITMENTS, INSTALLATION INSTRUCTIONS, VIDEOS & PARTS LIST

THIS IS A GUIDE ONLY — ACTUAL FITMENT MAY VARY

Tire Size	Regular Single	Regular Dual Triple	V-Bar Single	V-Bar Dual Triple	T2 Rallye Polar-S	Regular Wide Base	Quick TRAK	Mud Service Single	Mud Service Dual	1/4" Studded Single	1/4" Studded Dual
	Pg. # 61	Pg. # 61	Pg. # 62	Pg. # 62	Pg. # 63	Pg. # N/A	Pg # 56	Pg. # N/A	Pg. # N/A	Pg. # 63	Pg. # 63
305/50-15	A2216	A4217	A2816	A4817			P216				
275/60-15	A2229	A4229	A2829	A4829			LT47	A2437	A4437	3934	4934
325/60-15						A3229	LT54				
255/65-15							LT48	A2437	A4437	3935	
355/65-15						A3259	LT63				
225/70-15	A2216	A4217	A2816	A4817			P217				
235/70-15	A2216	A4217	A2816	A4817			LT47				
245/70-15	A2229	A4229	A2829	A4829			LT49	A2437	A4437	3934	4934
255/70-15	A2229	A4229	A2829	A4829			LT50	A2437	A4437	3934	4934
265/70-15	A2221	A4221	A2821	A4821			LT52	A2437	A4437		
285/70-15	A2219	A4219	A2819	A4819			LT54			3919	4919
215/75-15	A2216	A4217	A2816	A4817			LT47	A2433	A4433		
225/75-15	A2216	A4217	A2816	A4817			LT48	A2435	A4435		
235/75-15	A2219	A4219	A2819	A4819	247		LT50	A2435	A4435	3919	4919
245/75-15	A2221	A4221	A2821	A4821	250		LT51	A2437	A4437	3921	4921
255/75-15	A2228	A4228	A2828	A4828			LT52	A2439	A4439	3928	4928
265/75-15	A2221	A4221	A2821	A4821			LT54	A2437	A4437	3921	4921
305/75-15						A3229	LT62			3929	
245/85-15	A2228	A4228	A2828	A4828	245		LT55	A2441	A4441	3928	4928
225/50-16	A2209	A4209	A2809	A4809			P210				
265/55-16					255		P217				
275/55-16	A2229	A4229	A2829	A4829	255		LT47			3934	4934
235/60-16	A2211	A4211	A2811	A4811			P216				
255/60-16	A2229	A4229	A2829	A4829	247		LT47			3934	4934
285/60-16	A2228	A4228	A2828	A4828			LT51	A2439	A4439	3928	4928
235/65-16	A2227	A4227	A2827	A4827	247		LT47			3923	4923
255/65-16	A2229	A4229	A2829	A4829			LT50	A2437	A4437	3934	4934
265/65-16	A2229	A4229	A2829	A4829			LT52	A2437	A4437	3934	4934
275/65-16							LT52				
295/65-16						A3229	LT55			3929	
365/65-16					250		LT66				
215/70-16	A2216	A4217	A2816	A4817			LT47				
225/70-16	A2219	A4219	A2819	A4819			LT49	A2435	A4435	3919	4919
235/70-16	A2229	A4229	A2829	A4829			LT50			3934	4934
245/70-16	A2229	A4229	A2829	A4829			LT51			3934	4934
255/70-16	A2221	A4221	A2821	A4821	245		LT52	A2437	A4437	3921	4921
265/70-16	A2228	A4228	A2828	A4828	247		LT54	A2439	A4439	3928	4928
275/70-16					250	A3228	LT55				
285/70-16					255	A3229	LT55			3929	
305/70-16	A2238	A4238	A2838	A4838	265		LT62				
315/70-16						A3231	LT63			3931	
205/75-16	A2216	A4217	A2816	A4817			LT48	A2433H	A4433H		
215/75-16	A2216	A4217	A2816	A4817			LT49				
225/75-16	A2219	A4219	A2819	A4819			LT51	A2435	A4435	3919	4919
235/75-16	A2219	A4219	A2819	A4819			LT52	A2435	A4435	3919	4919
245/75-16	A2221	A4221	A2821	A4821	245		LT54	A2437	A4437	3921	4921
255/75-16	A2228	A4228	A2828	A4828			LT55	A2439	A4439	3928	4928
265/75-16	A2228	A4228	A2828	A4828	250		LT55	A2439	A4439	3928	4928
285/75-16	A2238	A4238	A2838	A4838			LT62				
295/75-16			3831		265	A3231	LT63			3931	
315/75-16			3831			A3231	LT66	A2441	A4441	3931	
205/80-16	A2229	A4229	A2829	A4829			LT50			3934	4934
235/80-16	A2219	A4219	A2819	A4819			LT54			3919	4919
325/80-16						A3251					
215/85-16	A2219	A4219	A2819	A4819	255		LT54	A2435	A4435	3919	4919
225/85-16	A2221	A4221	A2821	A4821	245		LT55	A2437	A4437	3921	4921
235/85-16	A2221	A4221	A2821	A4821			LT55	A2437	A4437	3921	4921

THIS IS A GUIDE ONLY. ACTUAL FITMENT MAY VARY AND CLEARANCES VARY, PLEASE CHECK

PREMIUM LIGHT TRUCK / SUV

LIGHT TRUCK PREMIUM FIT CHART

(CONTINUED ON NEXT PAGE)

THIS IS A GUIDE ONLY — ACTUAL FITMENT MAY VARY

Tire Size	Regular Single	Regular Dual Triple	V-Bar Single	V-Bar Dual Triple	T2 Rallye Polar-S	Regular Wide Base	Quick TRAK	Mud Service Single	Mud Service Dual	1/4" Studded Single	1/4" Studded Dual
	Pg. # 61	Pg. # 61	Pg. # 62	Pg. # 62	Pg. # 63	Pg. # N/A	Pg # 56	Pg. # N/A	Pg. # N/A	Pg. # 63	Pg. # 63
245/85-16	A2228	A4228	A2828	A4828			LT61	A2439	A4439	3928	4928
255/85-16	A2228	A4228	A2828	A4828			LT63	A2439	A4439	3928	4928
265/85-16	A2228	A4228	A2828	A4828			LT64	A2439	A4439	3928	4928
275/85-16							LT66				
305/85-16						A3259					
245/45-17							P212				
235/50-17							P214				
275/50-17	A2227	A4227	A2827	A4827	255		LT47			3923	4923
235/55-17					255		P216				
255/55-17	A2219	A4219	A2819	A4819			LT47			3919	4919
265/55-17							LT49				
275/55-17	A2227	A4227	A2827	A4827	255		LT50			3923	4923
235/60-17	A2227	A4227	A2827	A4827			LT48			3923	4923
245/60-17	A2229	A4229	A2829	A4829	247		LT49			3934	4934
255/60-17	A2227	A4227	A2827	A4827		A3210	LT50			3923	4923
265/60-17					255		LT51				
275/60-17					247	A3227	LT52			3927	
285/60-17	A2228	A4228	A2828	A4828	255		LT54	A2439	A4439	3928	4928
305/60-17						A3235	LT55			3935	
235/65-17	A2211	A4211	A2811	A4811	267		LT50				
245/65-17	A2227	A4227	A2827	A4827	267		LT52	A2439	A4439	3923	4923
255/65-17	A2228	A4228	A2828	A4828	255		LT52	A2439	A4439	3928	4928
265/65-17	A2227	A4227	A2827	A4827			LT54	A2439	A4439	3923	4923
305/65-17					267	A3229	LT61			3929	
235/70-17	A2219	A4219	A2819	A4819			LT52			3919	4919
245/70-17	A2227	A4227	A2827	A4827	255		LT54			3923	4923
255/70-17	A2228	A4228	A2828	A4828			LT55	A2440	A4440	3928	4928
265/70-17	A2228	A4228	A2828	A4828	267		LT55	A2439	A4439	3928	4928
275/70-17	A2228	A4228	A2828	A4828		A3227	LT60	A2439	A4439	3927	
285/70-17	A2238	A4238	A2838	A4838		A3228	LT62	A2440	A4440		
295/70-17						A3229	LT63			3929	
305/70-17						A3229	LT64			3929	
315/70-17					250	A3231	LT66			3931	
235/75-17	A2227	A4227	A2827	A4827	250		LT54			3923	4923
245/75-17	A2228	A4228	A2828	A4828	265		LT55	A2439	A4439	3928	4928
255/75-17	A2228	A4228	A2828	A4828			LT60	A2439	A4439	3928	4928
265/75-17							LT61				
285/75-17						A3229	LT64			3929	
235/80-17	A2221	A4221	A2821	A4821			LT60			3921	4921
275/80-17					267		LT66				
245/85-17					250		LT63				
295/45-18	A2227	A4227	A2827	A4827			LT49			3923	4923
285/50-18	A2228	A4228	A2828	A4828	255	A3227	LT51	A2439	A4439	3927	
225/55-18	A2229	A4229	A2829	A4829	275		LT47			3934	4934
235/55-18					275		LT48				
245/55-18	A2229	A4229	A2829	A4829			LT49			3934	4934
255/55-18	A2229	A4229	A2829	A4829			LT50	A2435	A4435	3934	4934
275/55-18	A2227	A4227	A2827	A4827	265	A3227	LT52			3923	4923
285/55-18	A2227	A4227	A2827	A4827	267	A3227	LT54			3923	4923
235/60-18	A2229	A4229	A2829	A4829			LT50			3934	4934
245/60-18	A2229	A4229	A2829	A4829			LT52			3934	4934
255/60-18	A2227	A4227	A2827	A4827			LT52			3923	4923
265/60-18	A2221	A4221	A2821	A4821			LT54			3921	4921
275/60-18	A2228	A4228	A2828	A4828	267		LT55	A2439	A4439	3928	4928
285/60-18	A2228	A4228	A2828	A4828			LT55	A2439	A4439	3928	4928
305/60-18						A3231	LT61			3931	
325/60-18						A3231	LT63			3931	

THIS IS A GUIDE ONLY.

ACTUAL FITMENT MAY VARY.

VERIFY CLEARANCES

VARY, PLEASE CHECK

THIS IS A GUIDE ONLY — ACTUAL FITMENT MAY VARY

PREMIUM LIGHT TRUCK / SUV

Tire Size	Regular Single	Regular Dual Triple	V-Bar Single	V-Bar Dual Triple	T2 Rallye Polar-S	Regular Wide Base	Quick TRAK	Mud Service Single	Mud Service Dual	1/4" Studded Single	1/4" Studded Dual
	Pg. # 61	Pg. # 61	Pg. # 62	Pg. # 62	Pg. # 63	Pg. # N/A	Pg # 56	Pg. # N/A	Pg. # N/A	Pg. # 63	Pg. # 63
225/65-18	A2229	A4229	A2829	A4829			LT51			3934	4934
235/65-18	A2229	A4229	A2829	A4829	255		LT52			3934	4934
255/65-18	A2229	A4229	A2829	A4829	247		LT55			3934	4934
265/65-18						A3228	LT55				
275/65-18	A2228	A4228	A2828	A4828	255	A3228	LT60	A2439	A4439	3928	4928
285/65-18	A2228	A4228	A2828	A4828	265		LT61	A2439	A4439	3928	4928
305/65-18						A3231	LT64			3931	
325/65-18						A3235	LT66				
355/65-18					267	A3254					
225/70-18							LT54				
255/70-18	A2228	A4228	A2828	A4828			LT60	A2439	A4439	3928	4928
265/70-18	A2228	A4228	A2828	A4828			LT61	A2439	A4439	3928	4928
275/70-18						A3231	LT63			3931	
285/70-18						A3231	LT64			3931	
305/70-18						A3231	LT67			3931	
265/75-18						A3229	LT64			3929	
275/75-18						A3229	LT65			3929	
235/80-18	A2228	A4228	A2828	A4828			LT62	A2439	A4439	3928	4928
275/45-19	A2229	A4229	A2829	A4829			LT49			3934	4934
285/45-19	A2227	A4227	A2827	A4827			LT50			3923	4923
255/50-19	A2227	A4227	A2827	A4827	255		LT50			3923	4923
235/55-19	A2219	A4219	A2819	A4819			LT51			3919	4919
245/55-19							LT52				
255/55-19							LT52				
305/30-20						A3257	P216				
275/40-20	A2227	A4227	A2827	A4827	255		LT49			3923	4923
295/40-20	A2228	A4228	A2828	A4828			LT51	A2439	A4439	3928	4928
245/45-20	A2229	A4229	A2829	A4829			LT49			3934	4934
255/45-20	A2229	A4229	A2829	A4829	255		LT50			3934	4934
275/45-20	A2228	A4228	A2828	A4828		A3227	LT52	A2439	A4439	3927	
295/45-20	A2228	A4228	A2828	A4828		A3227	LT54	A2439	A4439	3927	
305/45-20						A3229	LT54			3929	
255/50-20	A2227	A4227	A2827	A4827		A3227	LT52			3923	4923
265/50-20					267	A3227	LT54			3927	
275/50-20	A2228	A4228	A2828	A4828			LT54			3928	4928
285/50-20						A3228	LT55				
295/50-20						A3228	LT55				
305/50-20	A2238	A4238	A2838	A4838		A3231	LT60	A2440	A4440	3931	
325/50-20						A3231	LT62			3931	
275/55-20	A2238	A4238	A2838	A4838		A3228	LT60				
285/55-20							LT61				
255/60-20	A2228	A4228	A2828	A4828			LT60			3928	4928
275/60-20	A2238	A4238	A2838	A4838			LT62	A2440	A4440		
285/60-20	A2238	A4238	A2838	A4838			LT64				
325/60-20						A3235	LT68			3935	
355/60-20						A3251					
275/65-20						A3231	LT65			3931	
385/65-20						A3231				3931	
395/65-20						A3236					
295/30-22							LT50				
265/35-22							LT51				
285/35-22	A2228	A4228	A2828	A4828			LT52			3928	4928
265/40-22	A2227	A4227	A2827	A4827			LT54			3923	4923
305/40-22	A2238	A4238	A2838	A4838		A3228	LT55				
325/40-22	A2238	A4238	A2838	A4838			LT60				
275/45-22							LT55				
285/45-22							LT60				

THIS IS A GUIDE ONLY — ACTUAL FITMENT MAY VARY

Tire Size	Regular Single	Regular Dual Triple	V-Bar Single	V-Bar Dual Triple	T2 Rallye Polar-S	Regular Wide Base	Quick TRAK	Mud Service Single	Mud Service Dual	1/4" Studded Single	1/4" Studded Dual
	Pg. # 61	Pg. # 61	Pg. # 62	Pg. # 62	Pg. # 63	Pg. # N/A	Pg # 56	Pg. # N/A	Pg. # N/A	Pg. # 63	Pg. # 63
305/45-22	A2238	A4238	A2838	A4838			LT62				
325/50-22						A3235	LT67			3935	
305/60-22											
295/35-24							LT60				
305/35-24							LT61				
285/40-24						A3229	LT62			3929	
295/40-24						A3231	LT63			3931	
305/30-26							LT63				
27X8.50-14	A2216	A4216	A2816	A4816		A3237					
27X9.50-14	A2216	A4216	A2816	A4816							
29X9.50-14	A2216	A4216	A2816	A4816		A3237					
14X36.5-15						A3255					
27X9.50-15	A2229	A4229	A2829	A4829						3934	4934
28X8.50-15	A2211	A4211	A2811	A4811							
29X9.50-15	A2229	A4229	A2829	A4829		A3210		A2437	A4437	3934	4934
30X9.50-15	A2229	A4229	A2829	A4829		A3210		A2437	A4437	3934	4934
31X9.50-15						A3227		A2437	A4437	3927	
31X10.50-15						A3227				3927	
31X11.50-15						A3227				3927	
31X12.50-15						A3229				3929	
32X9.50-15						A3227				3927	
32X11.50-15						A3229				3929	
32X12.50-15						A3229				3929	
33X9.50-15						A3227				3927	
33X10.50-15						A3229				3929	
33X12.50-15						A3229				3929	
35X12.50-15						A3235				3935	
35X14-15						A3235				3935	
36X12.50-15						A3235				3935	
36X13.50-15						A3265					
36X14-15						A3251					
36X14.50-15						A3251					
37X12.50-15						A3235		A2445	A4445	3935	
37X14.50-15						A3251					
38X12.50-15						A3259					
38X14.50-15						A3259					
38X15-15						A3235				3935	
38X15.50-15						A3249					
38.5X16-15						A3249					
39X13.50-15						A3254					
40X17-15						A3251					
42X15-15						A3267					
44X18.50-15						A3269					
29X9.50-16						A3210					
31X16-16						A3259					
36.5X14-16						A3235				3935	
38X15-16						A3265					
30X9.50-16.5						A3210		A2435	A4435		
31X10.50-16.5						A3227				3927	
31X11.50-16.5						A3227				3927	
32X11.50-16.5						A3227				3927	
32X12.50-16.5						A3229				3929	
33X12.50-16.5						A3229				3929	
35X12.50-16.5						A3235		A2441	A4441	3935	
35X14-16.5						A3235				3935	
36X12.50-16.5						A3235				3935	
36X14-16.5						A3235				3935	

THIS IS A GUIDE ONLY.

ACTUAL FITMENT MAY

VARY AND CLEARANCES

VARY, PLEASE CHECK

PREMIUM LIGHT TRUCK / SUV

LIGHT TRUCK PREMIUM FIT CHART

THIS IS A GUIDE ONLY — ACTUAL FITMENT MAY VARY

Tire Size	Regular Single	Regular Dual Triple	V-Bar Single	V-Bar Dual Triple	T2 Rallye Polar-S	Regular Wide Base	Quick TRAK	Mud Service Single	Mud Service Dual	1/4" Studded Single	1/4" Studded Dual
	Pg. # 61	Pg. # 61	Pg. # 62	Pg. # 62	Pg. # 63	Pg. # N/A	Pg # 56	Pg. # N/A	Pg. # N/A	Pg. # 63	Pg. # 63
36X14.50-16.5						A3249					
37X12.50-16.5	A2248		A2848								
37X14.50-16.5						A3251					
38X15.5-16.5						A3235				3935	
38.5X15-16.5						A3235				3935	
38.5X16-16.5						A3249					
39.5X15-16.5						A3251					
40X17-16.5						A3251					
44X18.5-16.5						A3269					
33X12.50-17	A2238	A4238	A2838	A4838		A3229				3929	
37X12.50-17						A3235				3935	
37X13.50-17						A3251					
35X12.50-18						A3231				3931	
37X13.50-18						A3251					
33X12.50-20						A3231				3931	
35X12.50-20						A3236					
35X13.50-20						A3235				3935	
37X13.50-20						A3251					
40X15.50-20						A3255					

WWW.QUALITYCHAINCORP.COM

PREMIUM LIGHT TRUCK / SUV

LIGHT TRUCK / SUV CHAINS: PREMIUM

- REGULAR AND CAM STYLE
- SINGLE MOUNT
- DUAL/TRIPLE MOUNT



CAM



FIND PRICING IN JOBBER ON WEBSITE

HIGHWAY SERVICE: NOT FOR Plow, Forklift or Tow Truck

SINGLE MOUNT (1 PAIR PER BAG)				DUAL/TRIPLE MOUNT (1/2 PAIR PER BAG)				Cross Chain No.
REGULAR		CAM-STYLE		REGULAR		CAM-STYLE		
Stock No.	Wt./Pr.	Stock No.	Wt./Pr.	Stock No.	Wt./Pr.	Stock No.	Wt./Pr.	
A2209	20	A2209QC	23					A6219
A2211	22	A2211QC	25	A4211	47	A4211QC	52	A6221
A2214	29	A2214QC	31	A4214	52	A4214QC	54	
A2216	24	A2216QC	23	A4216	40	A4216QC	45	
A2219	26	A2219QC	25	A4219	43	A4219QC	43	
A2221	26	A2221QC	26	A4221	48	A4221QC	54	A6225
A2227	26	A2227QC	28	A4227	49	A4227QC	53	
A2228	27	A2228QC	30	A4228	51	A4228QC	56	
A2229	26	A2229QC	26	A4229	49	A4229QC	52	A6251
A2233	36	A2233QC	38	A4233	72	A4233QC	79	
A2237	40	A2237QC	42	A4237	89	A4237QC	93	

V-BAR LIGHT TRUCK / SUV CHAINS: PREMIUM

- REGULAR AND CAM STYLE
- SINGLE MOUNT
- DUAL/TRIPLE MOUNT



CAM



FIND PRICING IN JOBBER ON WEBSITE

HIGHWAY SERVICE: **NOT FOR** Plow, Forklift or Tow Truck

SINGLE MOUNT (1 PAIR PER BAG)				DUAL/TRIPLE MOUNT (1/2 PAIR PER BAG)				Cross Chain No.
REGULAR		CAM-STYLE		REGULAR		CAM-STYLE		
Stock No.	Wt./Pr.	Stock No.	Wt./Pr.	Stock No.	Wt./Pr.	Stock No.	Wt./Pr.	
A2809	22	A2809QC	23					A6819
A2811	25	A2811QC	26	A4811	47	A4811QC	52	
A2814	31	A2814QC	32	A4814	53	A4814QC	58	
A2816	25	A2816QC	25	A4816	53	A4816QC	49	A6821
A2819	28	A2819QC	27	A4819	49	A4819QC	53	
A2821	29	A2821QC	29	A4821	51	A4821QC	56	
A2827	28	A2827QC	30	A4827	50	A4827QC	55	A6825
A2828	32	A2828QC	35	A4828	56	A4828QC	60	
A2829	28	A2829QC	28	A4829	54	A4829QC	59	
A2833	39	A2833QC	42	A4833	79	A4833QC	84	A6851
A2837	46	A2837QC	46	A4837	96	A4837QC	101	

TEXAS LONG HORN U-GRIP ALLOY CHAINS

- MOST AGGRESSIVE TRACTION AVAILABLE IN A LADDER STYLE CHAIN
 - TWISTED SQUARE LINK WITH "U" STUDS
- FIND PRICING IN JOBBER ON WEBSITE



SINGLE (TYPE SS)



DUAL/TRIPLE (TYPE SDT)

9/32" (7 MM) DIAMETER CROSS CHAIN

Tire Size	SINGLE MOUNT (1 PAIR PER BAG)			DUAL/TRIPLE MOUNT (1/2 PAIR PER BAG)		
	Stock No.	Wt./Pr.	Cross Chain No.	Stock No.	Wt./Pr.	Cross Chain No.
LT225/70R19.5	3114U	32	6751	4114U	58	6751
LT235/75R15; LT215/85R16; LT235/75R16	3119U	27	6751	4119U	52	6751
LT225/75R16	3121U	29	6751	4121U	56	6751
7.50-16; 235/85R16; 245/75R16; LT245/85R16; LT255/85R16; LT265/75R16	3128U	30	6753	4128U	58	6753

5/16" (8 MM) DIAMETER CROSS CHAIN

Tire Size	TYPE SS SINGLE MOUNT (1 PAIR PER BAG)			TYPE SDT DUAL/TRIPLE MOUNT (1/2 PAIR PER BAG)		
	Stock No.	Wt./Pr.	Cross Chain No.	Stock No.	Wt./Pr.	Cross Chain No.
LT225/70R19.5	3129U	28	6760	4129U	79	6760
LT235/75R15; LT215/85R16; LT235/75R16	3130U	39	6760	4130U	72	6760
235/85R16; 245/75R16	3131U	49	6760	4131U	76	6760
LT245/85R16; LT255/85R16; LT265/75R16; LT265/70R17; LT245/75-17	3132U	43	6763	4132U	80	6763

9/32" (7 MM) DIAMETER CROSS CHAIN WIDE BASE

Tire Size	Stock No.	Wt./Pr.	Cross Chain No.
31X10.50-15; 31X11.50-15; 31X10.50-16.5; 31X11.50-16.5; 32X9.50-15; 33X9.50R15	3927U	42	6753
12-16.5LT; 31X12.50-15; 32X11.50-15; 32X12.50-15; 33X12.50-15; 33X12.50-16.5; 32X12.50-16.5; 255/85R16	3929U	46	6759

NORSE**STUDDED ALLOY LIGHT TRUCK CHAINS**
MADE IN NORWAY 

Premium studded ladder chain with aggressive studded tips for excellent traction in extreme conditions.



SINGLE (TYPE SS)



DUAL/TRIPLE (TYPE SDT)

FIND PRICING IN JOBBER ON WEBSITE**1/4" (5 MM) (.250) DIAMETER CROSS CHAIN**

Tire Size	TYPE SS (Single Truck Chain)			TYPE SDT (Dual/Triple Truck Chain)		
	Stock No.	Wt./Pr.	Cross Chain No.	Stock No.	Wt./Pr.	Cross Chain No.
LT225/70R19.5	3914N	31	6905N	4914N	52	6905N
LT235/75R15; LT215/85R16; LT225/75R16	3919N	27	6905N	4919N	52	6905N
7.50-16; 235/85R16; 245/75R16	3921N	29	6905N	4921N	56	6905N
LT245/85R16; LT255/85R16; LT265/75R16	3928N	30	6906N	4928N	58	6906N

9/32" (7 MM) (.281) DIAMETER CROSS CHAIN

Tire Size	TYPE SS (Single Truck Chain)			TYPE SDT (Dual/Triple Truck Chain)		
	Stock No.	Wt./Pr.	Cross Chain No.	Stock No.	Wt./Pr.	Cross Chain No.
LT225/70R19.5	3933N	42	6912N	4933N	72	6912N
LT235/75R15; LT215/85R16; LT235/75R16	3930N	39	6912N	4930N	72	6912N
235/85R16; 245/75R16	3939N	49	6912N	4931N	76	6912N
LT245/85R16; LT255/85R16; LT265/75R16	3932N	43	6913N	4932N	80	6913N

9/32" (7 MM) (.281) DIAMETER CROSS CHAIN WIDE BASE

Tire Size	Stock No.	Wt./Pr.	Cross Chain No.
31X10.50-15; 31X11.50-15; 31X10.50-16.5; 31X11.50-16.5; 32X9.50-15; 33X9.50R15	3927N	42	6914N
12-16.5LT; 31X12.50-15; 32X11.50-15; 32X12.50-15; 33X12.50-15; 33X12.50-16.5; 32X12.50-16.5; 255/85R16	3929N	46	6917N

T2**MADE IN EUROPE**

- Diamond Pattern Alloy chain designer for Light Trucks and SUV's with limited clearance.
- Built with the [Self-Tightening](#) system for easy installation.

QUALTRAX
MADE IN EUROPE**FIND PRICING IN JOBBER ON WEBSITE**

Tire Size	Part #	Wt./Pair
28X9.5-15; 215-16; 235/75-15; 215/85-16; 225/75-16; 225/70-16; 225/70-16; 6.50-17	245	13
245/70-15; 225/70-15; 225/75-16; 255/55-17; 235/75-16; 30X9.50-15; 8.40-15; 255/70-15; 235/70-16; 235/65-17; 275/60-15	247	10
9-15; 750-15; 700-16; 8-17.5; 205/75-17.5; 215/75-17.5; 255/65-16; 265/70-15; 245/70-16; 255/65-16; 235/80-16; 245/75-16; 235/65-17; 255/55-18; 265/60-17; 24/65-17; 255/55-18; 225/65-18; 245/60-18	250	13
10-15; 255/75-15; 265/75-15; 31X10.5-15; 255/70-16; 265/75-15; 255/60-17; 275/55-17; 255/55-18; 255/50-19; 275/55-17; 275/45-19; 275/40-20	255	14
31X11.5-15; 265/75-1; 265/70-16; 285/45-19; 265/60-18; 275/45-20; 315/35-20; 255/60-20	265	14
32X11.5-15; 275/60-16; 265/70-17; 285/55-18; 275/70-16; 275/60-17; 285/60-17; 275/70-17; 285/50-18; 285/60-18; 225/70-19.5; 265/50-20; 265/55-19	267	14

RALLYE

- Alloy Diamond Pattern Chain designed to be lightweight, reversible, durable and excellent traction for large trucks.

QUALTRAX
MADE IN EUROPE**FIND PRICING IN JOBBER ON WEBSITE****RALLYE 7 MM**

Tire Size	Part #	Wt./Pair
245/70-19.5; 265/70-19.5	275	44

QUALITY
CHAIN CORP

THIS IS A GUIDE ONLY — ACTUAL FITMENT MAY VARY

Tire Size	Regular Single	Regular Dual Triple	V-Bar Single	V-Bar Dual Triple	Mud Service Single	Mud Service Dual	Square Link Single	9/32" Studded Single	5/16" Studded Single	3/8" Studded Single	9/32" Studded Dual	5/16" Studded Dual	QUICK TRAK	Qual Trak Rallye
	Pg.# 66	Pg.# 66	Pg.# 66	Pg.# 66	Pg.# 67	Pg.# 67	Pg.# N/A	Pg.# 68	Pg.# 68	Pg.# 68	Pg.# 68	Pg.# 68	Pg.# N/A	Pg.# 68
9.00-15	A2237	A4237	A2837	A4837	A2435	A4412								250
8-19.5	A2214	A4214	A2814	A4814	A2439									
15-19.5														
16.5-19.5														
18-19.5														
6.50-20	A2233	A4233	A2833	A4833										
7.00-20	A2233	A4233	A2833	A4833										
7.50-20	A2237	A4237	A2837	A4837	A2441	A4435		3937			4937			
8.25-20	A2239	A4239	A2839	A4839	A2441	A4435	2139	3939			4939			
9.00-20	A2241	A4241	A2841	A4841	A2445	A4437	2141	3941	3541		4941	4541		
10.00-20	A2245	A4245	A2845	A4845	A2448	A4448	2145	3945	3545		4945	4545		310
11.00-20	A2251	A4251	A2851	A4851	A2452	A4461	2151		3551			4551		320
12.00-20	A2255	A4255	A2855	A4855	A2486	A4486	2155		3555	3655		4555		
10.00-22	A2249	A4249	A2849	A4849	A2452	A4461	2149	3949	3549	3649	4949	4549		315
11.00-22	A2255	A4255	A2855	A4855	A2486	A4486	2155		3555	3655		4555		
7-22.5	A2233	A4233	A2833	A4833	A2439									
8-22.5	A2237	A4237	A2837	A4837				3937			4937			
9-22.5	A2239	A4239	A2839	A4839	A2441	A4435	2139	3939			4939		T21	
10-22.5	A2241	A4241	A2841	A4841	A2445	A4437	2141	3941	3541		4941	4541	T25	
11-22.5	A2245	A4245	A2845	A4845	A2448	A4448	2145	3945	3545		4945	4545	T27	310
12-22.5	A2251	A4251	A2851	A4851	A2452	A4461	2151		3551			4551	T29	
12.5-22.5	A2255	A4255	A2855	A4855	A2452		2155							
15-22.5														
16.5-22.5														
18-22.5														
11.00-24	A2253	A4253	A2853	A4853	A2470	A4470								
12.00-24	A2257	A4257	A2857	A4857					3557	3657		4557		
11-24.5	A2249	A4249	A2849	A4849	A2452	A4461	2149	3949	3549	3649	4949	4549		315
12-24.5	A2255	A4255	A2855	A4855	A2486	A4486	2155		3555			4555		
265/70-19.5	A2237	A4237	A2837	A4837									T17	275
285/70-19.5	A2246	A4246	A2846	A4846									T19	
305/70-19.5	A2239	A4239					2139						T20G	
445/65-19.5														
245/45-20														
275/45-20														
285/50-20														
275/60-20														
245/70-20														
13/80-20	A2255	A4255	A2855	A4855	A2486									
14/80-20	A2257	A4257	A2857	A4857										
335/80-20														
365/80-20														
395/85-20														
44/18.00-20														
495/45-22.5														
445/50-22.5														445
425/55-22.5														
445/55-22.5														
495/55-22.5														
385/65-22.5														445
425/65-22.5														445
445/65-22.5														
225/70-22.5	A2233	A4233	A2833	A4833										

PREMIUM TRUCK

THIS IS A GUIDE ONLY.

ACTUAL FITMENT MAY VARY

AND CLEARANCES

VARY, PLEASE CHECK

WE CAN
 CUSTOM BUILD
 MOST CHAINS
 IF A SIZE OR PART #
 IS NOT LISTED

TRUCK CHAINS: PREMIUM

- REGULAR AND CAM STYLE
- SINGLE MOUNT
- DUAL/TRIPLE MOUNT



FIND PRICING IN JOBBER ON WEBSITE

HIGHWAY SERVICE: NOT FOR Plow, Forklift or Tow Truck

SINGLE MOUNT (1 PAIR PER BAG)				DUAL/TRIPLE MOUNT (1/2 PAIR PER BAG)				Cross Chain No.
REGULAR		CAM-STYLE		REGULAR		CAM-STYLE		
Stock No.	Wt./Pr.	Stock No.	Wt./Pr.	Stock No.	Wt./Pr.	Stock No.	Wt./Pr.	
A2233	36	A2233QC	38	A4233	72	A4233QC	74	A6251
A2237	40	A2237QC	42	A4237	89	A4237QC	91	
A2239	47	A2239QC	47	A4239	84	A4239QC	84	
A2241	46	A2241QC	49	A4241	85	A4241QC	89	
A2245	50	A2245QC	54	A4245	90	A4245QC	93	
A2246	47	A2246QC	49	A4246	84	A4246QC	86	A6253
A2247	49	A2247QC	51	A4247	89	A4247QC	92	
A2248	51	A2248QC	53					A6258
A2249	51	A2249QC	57	A4249	110	A4249QC	98	A6253
A2251	70	A2251QC	67	A4251	121	A4251QC	123	A6260
A2253	77	A2253QC	79	A4253	137	A4253QC	141	
A2255	70	A2255QC	73	A4255	128	A4255QC	128	A6263
A2257	82	A2257QC	82	A4257	145	A4257QC	150	
A2271	83	A2271QC	85	A4271	156	A4271QC	158	A6266
A2273	85	A2273QC	87	A4273	173	A4273QC	175	

V-BAR TRUCK CHAINS: PREMIUM

- REGULAR AND CAM STYLE
- SINGLE MOUNT
- DUAL/TRIPLE MOUNT

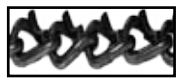

FIND PRICING IN JOBBER ON WEBSITE

HIGHWAY SERVICE: NOT FOR Plow, Forklift or Tow Truck

SINGLE MOUNT (1 PAIR PER BAG)				DUAL/TRIPLE MOUNT (1/2 PAIR PER BAG)				Cross Chain No.
REGULAR		CAM-STYLE		REGULAR		CAM-STYLE		
Stock No.	Wt./Pr.	Stock No.	Wt./Pr.	Stock No.	Wt./Pr.	Stock No.	Wt./Pr.	
A2833	39	A2833QC	42	A4833	79	A4833QC	81	A6822
A2837	46	A2837QC	46	A4837	96	A4837QC	101	
A2839	47	A2839QC	51	A4839	93	A4839QC	93	
A2841	54	A2841QC	54	A4841	93	A4841QC	96	
A2845	67	A2845QC	58	A4845	102	A4845QC	104	
A2846	54	A2846QC	53	A4846	94	A4846QC	96	A6853
A2847	55	A2847QC	55	A4847	104	A4847QC	103	
A2848	58	A2848QC	60					A6858
A2849	58	A2849QC	59	A4849	103	A4849QC	112	A6853
A2851	71	A2851QC	71	A4851	129	A4851QC	133	A6860
A2853	82	A2853QC	83	A4853	147	A4853QC	152	
A2855	74	A2855QC	78	A4855	139	A4855QC	140	A6863
A2857	86	A2857QC	88	A4857	152	A4857QC	157	
A2871	90	A2871QC	92	A4871	166	A4871QC	168	A6866
A2873	90	A2873QC	93	A4873	184	A4873QC	186	

MUD SERVICE TRUCK CHAINS PREMIUM

SINGLE MOUNT DUAL/TRIPLE MOUNT
HEAVY DUTY CROSS CHAIN WITH
EXTRA HEAVY HOOKS



FIND PRICING IN JOBBER ON WEBSITE

3/8" (10 MM) DIAMETER CROSS CHAIN

(Packed 1 Pair Per Bag)

(Packed 1/2 Pair Per Bag)

TIRE SIZE	SINGLE			DUAL		
	Stock No.	Wt./Pr.	Cross Chain No.	Stock No.	Wt./Pr.	Cross Chain No.
8.25-20; 9-22.5; 7.50-20; 10.00-15; 8.25-15; 11R15; 8.5-17.5; 245/75-22.5; 255/70-22.5; 35X12.50-16.5; 245/70-22.5; 36X12.50-16.5; 245/85-15; 265/70-16; 235/80-22.5; 255/80-22.5	A2441	66	A6434	A4435	128	A6434
9.00-20; 10-22.5; 265/75-22.5; *275/80-22.5; 275/70-22.5; 37X12.50-15; 315/75-16	A2445	72	A6434	A4437	146	A6434
10.00-20; 11-22.5; *275/80-22.5; 295/75-22.5; 285/75-22.5; 295/80-22.5	A2448	79	A6434	A4448	155	A6434
11.00-20; 10.00-22; 12-22.5; 11-24.5; 12.5-22.5; 285/75-24.5; 275/80-24.5; 305/75-24.5; 315/75-24.5; 285/80-24.5	A2452	90	A6434	A4461	148	A6434
11.00-24	A2470	99	A6438	A4470	175	A6438
12.00-20; 11.00-22; 12-24.5; 315/80-22.5; 13/80-20	A2486	95	A6438	A4486	175	A6438

TEXAS LONG HORN U-GRIP ALLOY CHAINS

• MOST AGGRESSIVE TRACTION AVAILABLE IN A LADDER STYLE CHAIN

• TWISTED SQUARE LINK WITH "U" STUDS

FIND PRICING IN JOBBER ON WEBSITE



SINGLE (TYPE SS)

DUAL/TRIPLE (TYPE SDT)

9/32" (7 MM) DIAMETER CROSS CHAIN

TIRE SIZE	TYPE SS SINGLE MOUNT (1 PR / BAG)		TYPE SDT D/T MOUNT (1/2 PR / BAG)		Cross Chain
	Stock No.	Wt./Pr	Stock No.	Wt./Pr	
7.50-20; 8-22.5	3137U	44	4137U	79	6751
8.25-20; 9-22.5	3139U	49	4139U	87	
9.00-20; 10-22.5	3141U	52	4141U	92	
10.00-20; 11-22.5	3145U	56	4145U	107	6753
10.00-22; 11-24.5	3149U	69	4149U	123	

5/16" (8 MM) DIAMETER CROSS CHAIN

TIRE SIZE	Stock No.	Wt./Pr	Stock No.	Wt./Pr	Cross Chain
10.00-20; 11-22.5	3545U	70	4545U	136	
10.00-22; 11-24.5	3549U	84	4549U	144	
11.00-20; 12-22.5	3551U	77	4551U	140	6763
11.00-22; 12-20; 12-24.5	3555U	78	4555U	142	
12.00-24	3557U	84	4557U	149	

3/8" (10 MM) DIAMETER CROSS CHAIN

TIRE SIZE	Stock No.	Wt./Pr	Stock No.	Wt./Pr	Cross Chain
11.00-22; 12.00-20	3655U	100	4655U	208	
12.00-24	3657U	123	4657U	219	6736

NORSE STUDDED ALLOY TRUCK CHAINS

Premium studded ladder chain with aggressive studded tips for excellent traction in extreme conditions.

**FIND PRICING
IN JOBBER ON
WEBSITE**

MADE IN NORWAY 



SINGLE (TYPE SS)



DUAL/TRIPLE (TYPE SDT)

9/32" (7 MM) DIAMETER CROSS CHAIN

TIRE SIZE	TYPE SS (Single Truck Chain)		TYPE SDT (Dual/Triple Truck Chain)		Cross Chain
	Stock No.	Wt./Pr	Stock No.	Wt./Pr	
7.50-20; 8-22.5	3937N	44	4937N	79	6912N
8.25-20; 9-22.5	3939N	49	4939N	87	6913N
9.00-20; 10-22.5	3941N	52	4941N	92	6914N
10.00-20; 11-22.5	3945N	56	4945N	107	6914N
10.00-22; 11-24.5	3949N	69	4949N	123	6915N

5/16" (8 MM) DIAMETER CROSS CHAIN

TIRE SIZE	TYPE SS (Single Truck Chain)		TYPE SDT (Dual/Triple Truck Chain)		Cross Chain
	Stock No.	Wt./Pr	Stock No.	Wt./Pr	
9.00-20; 10-22.5	3541N	67	4541N	119	6922N
10.00-20; 11-22.5	3545N	70	4545N	136	6923N
10.00-22; 11-24.5	3549N	84	4549N	144	
11.00-20; 12-22.5	3551N	77	4551N	140	6924N
11.00-22; 12-20; 12-24.5	3555N	78	4555N	142	6925N
12.00-24	3557N	84	4557N	149	

3/8" (10 MM) DIAMETER CROSS CHAIN

TIRE SIZE	TYPE SS (Single Truck Chain)		TYPE SDT (Dual/Triple Truck Chain)		Cross Chain
	Stock No.	Wt./Pr	Stock No.	Wt./Pr	
10.00-22; 11-24.5	3649N	114	4649N	213	6927N
11.00-22; 12.00-20	3655N	100	4655N	209	
12.00-24	3657N	123	4657N	219	6928N

7/16" (11.5 MM) DIAMETER CROSS CHAIN

12.00-24	3758N	135	4758N	240	6935N
----------	--------------	-----	--------------	-----	-------

RALLYE / SNOW TRAX / POLAR-S

- Alloy Diamond Pattern Chain designed to be lightweight, reversible, durable and excellent traction for large trucks.

QUALTRAX
MADE IN EUROPE

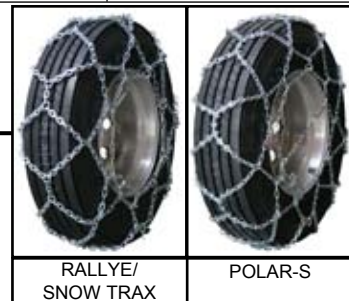

FIND PRICING IN JOBBER ON WEBSITE

RALLYE

9/32" (7 MM)

TIRE SIZE	PART #	Cross Chain	WT./PAIR
245/70-19.5; 265/70-19.5	275	275XC	44
10.00-20; 11X22.5; 12.4-20; 12/80-20; 275/80-22.5; 305/70-22.5; 315/70-22.5	310	310XC	71
11X24.5; 10.00-22; 285/75-24.5; 285/80-24.5; 315/80-22.5; 12R22.5	315	315XC	72
11.00-20; 315/75-22.5; 305/75-24.5; 315/75-24.5	320	320XC	78

SNOW TRAX **7/32" (5.7 MM)**

TIRE SIZE	PART #	Cross Chain	WT./PAIR
10.00-20; 11X22.5; 12.4-20; 12/80-20; 275/80-22.5; 305/70-22.5; 315/70-22.5	311	311XC	50
11X24.5; 10.00-22; 285/75-24.5; 285/80-24.5	312	312XC	51

POLAR-S **9/32" (7 MM)**

TIRE SIZE	PART #	Cross Chain	WT./PAIR
10.00-20; 11X22.5; 12.4-20; 12/80-20; 275/80-22.5; 305/70-22.5; 315/70-22.5	317	317XC	89
11X24.5; 10.00-22; 285/75-24.5; 285/80-24.5	318	318XC	91

POLAR-S **7/32" (5.7 MM)**

TIRE SIZE	PART #	Cross Chain	WT./PAIR
445/50-22.5; 385/65-22.5	445	445XC	71

THIS IS A GUIDE ONLY — ACTUAL FITMENT MAY VARY

Tire Size	Regular Round Twist	Square Link 4-Link	Square Link 2-Link	Duo H-Pattern	Regular Tractor	8mm DRQ	10mm DRQ	11mm DRQ	10mm DRSQ
	Pg. # 42	Pg. # 43	Pg. # 43	Pg. # 49	Pg. # 48	Pg. # 47	Pg. # 47	Pg. # 47	Pg. # 47
10.5/80-18					A0832				
10-32				ADUO218					
10-38				ADUO232					
11.2-16				ADUO214					
11.2-24				ADUO214	A0836				
11.2-28				ADUO226	A0838				
11.2-32				ADUO218					
11.2-34				ADUO224	A0846				
11.2-36				ADUO224	A0846				
11.2-38				ADUO232	A0862				
11.2-44				ADUO236					
11.2-48				ADUO247					
11.0-16					A0822				
11-28				ADUO218					
11-36				ADUO232					
11-38				ADUO232					
12.4-24				ADUO229	A0852				
12.4-28				ADUO218	A0856				
12.4-36				ADUO232	A0862				
12.4-38				ADUO232	A0862				
12.4-40				ADUO246					
12.4-42				ADUO246					
12.4-46				ADUO248					
12.4-48				ADUO259					
12.4-52				ADUO259					
12.4-54				ADUO261					
12.5X80-18					A0834				
12-28				ADUO242					
12-36				ADUO246					
13.5-16.1				ADUO214	A0838				
13.00X24	A2612	6512N	6512-2N	ADUO242	A0859				
13.6-24				ADUO240	A0856				
13.6-26				ADUO240	A0858				
13.6-28	A2612	6512N	6512-2N	ADUO242	A0859				
13.6-36				ADUO246	A0866				
13.6-38				ADUO246	A0866				
13.9-36				ADUO246	A0866				
15.00-20	A2612	6512N	6512-2N						
14.00-24	A2615	6515N	6515-2N	ADUO262		538DRQ	540DRQ		540DRSQ
14.00-25	A2615	6515N	6515-2N						
14.75X80-20	A2612	6512N	6512-2N						
14.9-24	A2612	6512N	6512-2N	ADUO242	A0859				
14.9-26				ADUO250	A0869				
14.9-28				ADUO250	A0869				
14.9-30				ADUO252	A0876				
14.9-38				ADUO254	A0871				
14.9-46				ADUO256					
15.5-25	A2612	6512N	6512-2N						
15.5-38				ADUO270	A0879				
16.00-20	A2624	6524N	6524-2N						
16.00-24	A2627	6527N	6527-2N						
16.00-25	A2627	6527N	6527-2N						

THIS IS A GUIDE ONLY. ACTUAL FITMENT MAY VARY AND CLEARANCES VARY, PLEASE CHECK

PREMIUM LOADER - GRADER - TRACTOR 

THIS IS A GUIDE ONLY — ACTUAL FITMENT MAY VARY

Tire Size	Regular Round Twist	Square Link 4-Link	Square Link 2-Link	Duo H-Pattern	Regular Twist Tractor	8mm DRQ	10mm DRQ	11mm DRQ	10mm DRSQ
	Pg. # 42	Pg. # 43	Pg. # 43	Pg. # 49	Pg. # 48	Pg. # 47	Pg. # 47	Pg. # 47	Pg. # 47
16.9-24	A2615	6515N	6515-2N	ADUO262	A0874				
16.9-26	A2615	6515N	6515-2N	ADUO262	A0876				
16.9-28	A2615	6515N	6515-2N	ADUO262	A0876				
16.9-30				ADUO266	A0877				
16.9-32				ADUO266	A0877				
16.9-34				ADUO270	A0879				
16.9-38				ADUO272	A0880				
17.5-25	A2624	6524N	6524-2N	ADUO268			580DRQ		580DRSQ
17.5L-24	A2615	6515N	6515-2N	ADUO262	A0874				
18.00-25	A2636	*	*						
18.00-26	A2636	*	*						
18.00-33	A2642	*	*						
18.4-16.1				ADUO264	A0881				
18.4-24				ADUO268	A0883				
18.4-26				ADUO268	A0883				
18.4-28				ADUO269	A0884				
18.4-30				ADUO271	A0885				
18.4-34				ADUO273	A0887				
18.4-38				ADUO274	A0889				
18.4-42				ADUO277	A0894				
18.4-46				ADUO277					
19.5-24	A2627	6527N	6527-2N	ADUO268	A0883				
20.5-25	A2633	6533N	6533-2N					592DRQ	590DRSQ
20.8-34				ADUO272	A0890				
20.8-38				ADUO276	A0892				
20.8-42				ADUO285					
21.00-24	A2648	*	*						
21.00-25	A2648	*	*						
21.00-35	A2654	6554N	6554-2N						
21L-24	A2636	*	*	ADUO271	A0885				
23.1-26				ADUO280	A0891				
23.1-28				ADUO280					
23.1-30				ADUO281	A0893				
23.1-34				ADUO282	A0895				
23.5-25	A2645	6545N	6545-2N					602DRQ	600DRSQ
24.5-32				ADUO278					
24.00-25	A2660	*	*						
24.00-35	A2686	*	*						
25.5-25	A2645	6545N	6545-2N						
25/65-25									
26.5-25	A2657	6557N	6557-2N						620DRSQ
26.5-29	A2660	*	*						
28L-26									
29.5-25	A2672	6572N	6572-2N						
29.5-29	A2675	6575N	6575-2N						
29.5-35	A2688	*	*						
39.5/85-20	A2615	6515N	6515-2N						
30.5-32				ADUO283					
33.5-33	A2678	*	*						
35/65-33	A2680	*	*						
37.5-33	A2682	*	*						
40X19-19.5				ADUO264					

THIS IS A GUIDE ONLY.

ACTUAL FITMENT MAY

VARY AND CLEARANCES

VARY, PLEASE CHECK

* SPECIAL BUILD—CALL FOR PRICE & AVAILABILITY

WWW.QUALITYCHAINCORP.COM

LOADER GRADER PREMIUM FIT CHART

THIS IS A GUIDE ONLY — ACTUAL FITMENT MAY VARY

Tire Size	Regular Round Twist	Square Link 4-Link	Square Link 2-Link	Duo H-Pattern	Regular Twist Tractor	8mm DRQ	10mm DRQ	11mm DRQ	10mm DRSQ
	Pg. # 42	Pg. # 43	Pg. # 43	Pg. # 49	Pg. # 48	Pg. # 47	Pg. # 47	Pg. # 47	Pg. # 47
41X14-20				ADUO250	A0858				
420/70-24	A2624	6524N	6524-2N						
44/1800-20	A2612	6512N	6512-2N						
440/80-28				ADUO269	A0884				
445/65-19.5	A2612	6512N	6512-2N						
480/80-20				ADUO277					
495/55-22.5	A2612	6512N	6512-2N						
555/70-25	A2633	6533N	6533-2N						
600X55-34									
700X50-265									
700X55-34									
705/70-25	A2648	*	*						
73X44-32									
8.3-24					A0822				
8.3-44				ADUO228					
9.50-40				ADUO228					
9.5-16					A0829				
9.5-18					A0822				
9.5-24				ADUO214	A0832				
9.5-28				ADUO214	A0836				
9.5-32				ADUO226					
9.5-44				ADUO227					
9.5-48				ADUO236					
12.4-16					A0836				
340/80-18					A0836				
13.6-16					A0850				
15-22.5					A0852				
21.5-16					A0882				
21.5L-16.1					A0882				

* SPECIAL BUILD—CALL FOR PRICE & AVAILABILITY

THIS IS A GUIDE ONLY.
ACTUAL FITMENT MAY VARY AND CLEARANCES VARY, PLEASE CHECK

**WE CAN
CUSTOM BUILD MOST
CHAINS
IF A SIZE OR PART #
IS NOT LISTED**

ALLOY STUDDED LINK

FOR PLOWS, GRADERS, FORKLIFTS, SCRAPERS, LOADERS, ETC.



Large sizes of the anti-skid chain can be used for farming, logging, construction or other off-the-road work. These larger chains are also available in an "H" pattern design that fits the tire well, reduces wear and prevents the chain from slipping between the tire treads. It also makes mounting and removing the chains easier. Stud tips extra hard.

FIND PRICING IN JOBBER ON WEBSITE

TIRE SIZE	Diameter	NORWAY			Diameter	ASIA		
		Stock No.	Wt./Pr.	Cross Chain No.		Stock No.	Wt./Pr.	Cross Chain No.
13.0-24/25; 14.00-20/21; 15.5-25; 14.75/80R20; 44/1800R20; 445/65R19.5; 495/55R22.5	10 MM	2912	170	6930N	10 MM	9912	170	6930
14.00-24; 14.00-25; 395/8R520	10 MM	2915	164	6930N	10 MM	9915	164	6930
16.00-20.21; 420/70R24	11.5MM	2924	196	6940N	11.5MM	9924	196	6940
16.00-24; 16.00-25; 19.5L-24; 17.5-25	11.5MM	2927	222	6940N	11.5MM	9927	222	6940
20.5-25; 555/70-25	11.5MM	2933	268	6950N	11.5MM	9933	268	6950
18.00-25; 18.00-26; 21LX24	11.5MM	2936	248	6950N	11.5MM	9936	248	6950
18.00-33	11.5MM	2942	299	6950N	11.5MM	9942	299	6950
23.5-25; 25.5-25	13 MM	2945	388	6960N	13 MM	9945	388	6960
21.00-24; 21.00-25; 705/70R25	13 MM	2948	401	6960N	13 MM	9948	401	6960
21.00-25	13 MM	2954	534	6960N	13 MM	9954	534	6960
26.5-25	13 MM	2957	482	6970N	13 MM	9957	482	6970
24.00-25; 26.5-29	13 MM	2960	495	6970N	13 MM	9960	495	6970
29.5-25	13 MM	2972	528	6980N	13 MM	9972	528	6980
29.5-29	13 MM	2975	558	6980N	13 MM	9975	558	6980
33.5-33	13 MM	2978	610	6990N	13 MM	9978	*	6990
35/65-33	13 MM	2980	681	6991N	13 MM	9980	*	6991
37.5-33	13 MM	2982	*	6992N	13 MM	9982	*	6992
24.00-35	13 MM	2986	*	6993N	13 MM	9986	*	6993
29.5-35	13 MM	2988	*	6994N	13 MM	9988	*	6994

* SPECIAL BUILD

NORSE H-PATTERN STUDDED CHAIN

STUDED TRACTION FOR GRADERS AND SKIDDERS
ALLOY STEEL CONSTRUCTION FOR MAXIMUM LIFE
STUD TIPS ARE EXTRA HARD
NON-STUDED AVAILABLE:

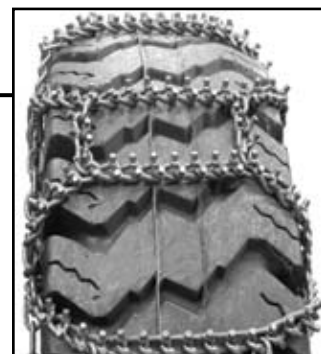

*Add (NS) to Stock Number, i.e. 8203 becomes 8203NS

FIND PRICING IN JOBBER ON WEBSITE

MADE IN NORWAY 

TIRE SIZES		3/8" CROSS CHAIN			7/16" CROSS CHAIN					
LOADER GRADER	BACK HOE TRACTOR	Stock No.	Wt./Pr.	Cross Chain No.	Stock No.	Wt./Pr.	Cross Chain No.			
13.00-24	13.6-28	8203	231	8501	8311	278	8503			
14.00-24; 15.5-25	17.5L-24; 16.9-24; 16.9-28	8204	270	8502	8311	278	8503			
16.00-24; 16.00-25	19.5-L24; 18.4-24	8205	253	8502	8312	281	8504			
18.4-28	18.4-26; 16.9-30; 18.4-30	8206	275	8502	8307	324	8504	Stock No.	Wt./Pr.	Cross Chain No.
16.00-20; 17.5-25					8313	315	8504	8413	346	8507
18.00-25; 20.5-25	18.4-30; 21L-24; 23.1-34				8314	340	8505	8414	400	8508
23.5-25; 25/65/25; 2100-25; 20.8-34	23.1-26; 18.4-34				8315	389	8506	8416	554	8509
21.00-35								8417	593	8509
	24.5-32; 28.1-26							8421	630	8510
26.5-25; 26.5-29; 24.00-25								8422	640	8510
29.5-25	30.5-32							8423	649	8511
29.5-29								8424	701	8511

ACCESSORIES

CROSS CHAIN (Continuous)



REGULAR TWISTED LINK: [FIND PRICING IN JOBBER ON WEBSITE](#)

REGULAR

PREMIUM

Nominal Size	Chain Diameter	Std. Pkg.	HARDENED		HARDENED	
			Stock No.	Wt./Pkg.	Stock No.	Wt./Pkg.
1/0	3/16" .177	100'	30177	24	A30177N	24
3/0	13/64" .207	100'	30207	39	A30207N	39
4/0	7/32" .218	100'	30218	49	A30218N	49
5/0	1/4" .234	100'			A30224N	51
6/0	9/32" .281	100'	30281	66	A30281N	66
7/0	5/16" .312	50'	30312	40	A30312N	40
9/0TRUCK	3/8" .375	50'	30375	64	A30375N	64
9/0TRACTOR	3/8" .375	50'			A30375TRTN	64
11/0	7/16" .437	50'	30437	92	A30437N	92
14/0	17/32" .531	50'	30531	140	A30531N	140
	3/4" .750	50'	30750	258		

TWISTED LINK V BAR

[FIND PRICING IN JOBBER ON WEBSITE](#)



Nominal Size	Chain Diameter	Std. Pkg.	REGULAR V-BAR		PREMIUM V-BAR	
			Stock No.	Wt./Pkg.	Stock No.	Wt./Pkg.
4/0	5.5 MM 7/32" .218	100'	38218	51	A38218N	58
6/0	7 MM 9/32" .281	50'	38281	43	A38281N	44
7/0	8.2 MM 5/16" .312	50'	38312	54	A38312N	56
9/0	10 MM 3/8" .375	50'	38375	80		

TWISTED LINK ALLOY

[FIND PRICING IN JOBBER ON WEBSITE](#)



NON-STUDED



STUDED

Nominal Size	Chain Diameter	Std. Pkg.	NON-STUDED		STUDED		PREMIUM STUDED	
			Stock No.	Wt./Pkg.	Stock No.	Wt./Pkg.	Stock No.	Wt./Pkg.
4/0	7/32" .218	100'	33218	49				
5/0	1/4" .250	100'					39250N	61
6/0	9/32" .281	100'	33281	66			39281N	94
7/0	5/16" .312	50'	33312	40			39312N	62
9/0	3/8" .375	50'	33375	64	39375	90	39375N	90
11/0	7/16" .437	50'	33437	92	39437	98	39437N	98
14/0	17/32" .531	50'	33531	140	39531	122	39531N	122

SQUARE LINK ALLOY

[FIND PRICING IN JOBBER ON WEBSITE](#)



Non-Twist Square Link



Twist Square Link

Nominal Size	Chain Diameter	Std. Pkg.	REGULAR		PREMIUM		REGULAR	
			Stock No.	Wt./Pkg.	Stock No.	Wt./Pkg.	Stock No.	Wt./Pkg.
4/0	5.5 MM 7/32" .218	100'	31218	47	A31218N	48		
6/0	7 MM 9/32" .281	50'	31281	38	A31281N	43	34281	44
7/0	8.2 MM 5/16" .312	50'	31312	48	A31312N	51	34312	54
9/0	10 MM 3/8" .375	50'	31375	83	A31375N	85	34375	89
11/0	11.5 MM 7/16" .437	50'	31437	106	A31437N	114	34437	115
14/0	13 MM 17/32" .531	50'	31531	180	A31531N	180		
	19 MM 3/4" .750	50'	31750	303				

U-GRIP ALLOY

[FIND PRICING IN JOBBER ON WEBSITE](#)



Nominal Size	Chain Diameter	Std. Pkg.	U-GRIP CHAIN	
			Stock No.	Wt./Pkg.
9/0	10 MM 3/8" .375	50'	31375U	92
11/0	11.5 MM 7/16" .437	50'	31437U	99
14/0	13 MM 17/32" .531	50'	31531U	128

STRAIGHT LINK SIDE CHAIN UNHARDENED: (Continuous)



FIND PRICING IN JOBBER ON WEBSITE

Regular

Premium Plus

Nominal Size	Chain Diameter	Std. Pkg.	Stock No.	Wt./Pkg.	Stock No.	Wt./Pkg.
1/0	11/64" .177	100'	40177	23		
2/0	3/16" .192	100'	40192	25		
3/0	13/64" .207	100'	40207	30		
4/0	7/32" .218	100'	40218	35	A40218N	35
6/0	9/32" .281	100'	40281	53	A40281N	53
7/0 TRUCK	5/16" .312	100'	40312	69	A40312N	69
9/0	3/8" .375	50'	40375	53	A40375N	53
11/0	7/16" .437	50'	40437	75	A40437N	75
14/0	17/32" .531	50'	40531	118	A40531N	118
	3/4" .750	50'	40750	258		

HARDENED: (Continuous)

7/0	5/16" .312	100'	40312H	68
9/0	3/8" .375	50'	40375H	52
11/0	7/16" .437	50'	40437H	71

CAM SIDE CHAIN

(Precut with 4 Cams and
1 End Fastener Per Rail)

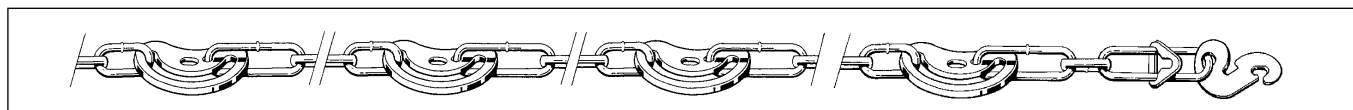

Stock No.	End Fastener	Nominal Size	Chain Diameter	Length/Pc.	Std. Pkg.	Wt./Pkg.
40218C	15003	4/0	7/32" .218	86"	10	31
40281C	15004	6/0	9/32" .281	120"	10	61
40312C	15004	7/0 TRUCK	5/16" .312	120"	10	86

CAMS FOR SIDE CHAIN

FIND PRICING IN JOBBER ON WEBSITE

Stock No.	Nominal Size	Application	Std. Pkg.	Wt./Pkg.
CAM4	4/0	Light Truck	1	1
CAM6	6/0	Heavy Truck	1	1
CAM7	7/0	Heavy Truck	1	1

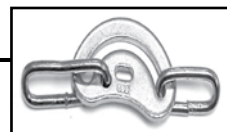

CROSS CHAIN HOOKS

Regular

Premium Plus

Chain Diameter	Application	Stock No.	St. Pkg.	Wt./Pkg.	Stock No.	Std. Pkg.	Wt./Pkg.
3/16" .177	Passenger Car (1100+1300)	20177	50	2	A20177N	50	2
13/64" .207	Passenger Car (1200+1300)	20230	50	4	A20230N	50	4
1/4" .250	Light Truck	20250	50	5	A20250N	50	5
5/16" .312	Medium Truck	20312	50	8	A20312N	50	8
3/8" .375	Heavy Truck	20375	50	12	A20375N	50	12
3/8" .375	Extra Long Pitch Alloy				A20375NL	50	13
13/32" .406	Tractor	20406	50	17	A20406N	50	17
7/16" .437	Grader	20437	50	22	A20437N	50	22
7/16" .437	Short Pitch Alloy				A20437NS	50	23
17/32" .531	Loader (Alloy)	20531	25	28	A20531N	25	28



Regular



Premium Plus

SWIVEL HOOKS

Stock No.	Chain Diameter	Application	Std. Pkg.	Wt./Pkg.
20451JH	7/16" .437	9/0 Swivel Hook	50	13
20450JH	9/16" .563	11/0 Swivel Hook	50	14
20455JH	1/2" .531	14/0 Swivel Hook	50	23
20375RJH	7/16" .437	9/0 Hook with 9/0 Swivel	50	25
20437RJH	9/16" .563	11/0 Hook with 11/0 Swivel	50	35



Swivel J Hook



Ruggo Hook

SIDE CHAIN FASTENERS FIND PRICING IN JOBBER ON WEBSITE

Stock No.	Application	Overall Length	Std. Pkg.	Wt./Pkg.
5308	Passenger, Light Truck	3"	25 PCS.	2
5309	Medium & Heavy Truck	6"	12 PCS.	3
5310	Tractor	8"	12 PCS.	4
5311	Medium & Heavy Truck	5"	12 PCS.	4
5313	Medium Truck	5"	12 PCS.	4



15003	Light Truck	4"	25 PCS.	5
15004	Medium & Heavy Truck	6"	25 PCS.	12
15008	Heavy Grader	7"	1 PC.	1



15NR4	Light Truck Norse Style Fastener	5"	1 PC.	1
15NR6	Heavy Truck Norse Style Fastener	7"	1 PC.	1
15NR9	Grader Norse Style Fastener	9"	1 PC.	1



15005	Heavy Grader	6"	1 PC.	1
15007	Light Grader	7"	1 PC.	1



SIDE CHAIN FASTENERS FIND PRICING IN JOBBER ON WEBSITE

Stock No.	Application	Std. Pkg.	Wt. Pkg.
A5308	Passenger, Light Truck	24 PCS.	2
A15003C	Light Truck	25 PCS.	5
A15004C	Medium & Heavy Truck	25 PCS.	12



CHAIN REPAIR PLIERS FIND PRICING IN JOBBER ON WEBSITE

Stock No.	Application	Description	Std. Pkg.	Wt./Pkg.
7301	Passenger Car	Small	1	1



7300HD	Passenger Car & Light Truck	Medium H.D.	1	2.75
--------	-----------------------------	-------------	---	------



7502S	All Truck & Tractor	Short Handle 18"	1	5
7302	All Truck & Tractor	Large 36"	1	7



CHAIN/BOLT CUTTERS FIND PRICING IN JOBBER ON WEBSITE

Stock No.	Application	Description	Std. Pkg.	Wt./Pkg.
BC18	Passenger Car	18"	1	3
BC24	Light Truck	24"	1	5
BC30	Truck	30"	1	8
BC36	Off Road	36"	1	12



QUICK HOOKS FIND PRICING IN JOBBER ON WEBSITE

Stock No.	Chain Diameter	Inside Pitch	Application	Std. Pkg.	Wt./Pkg.
10218	7/32"	1-7/8"	Passenger	25	1
10250	1/4"	1-7/8"	Garden Tractor	25	1
10281	9/32"	2-1/8"	Light Truck	25	2
10312	5/16"	2-1/2"	Medium Truck	25	2
10375	3/8"	2-1/8"	Heavy Truck	25	4
10406	7/16"	3"	Off Road	25	6
10N95	5/16"	2-1/8"	Off Road Norse Type	1	.18



CROSS CHAIN REPAIR LINKS

Stock No.	Chain Diameter	Application	Std. Pkg.	Wt./Pkg.
9233	3/0	Passenger Car	50	1
9253	5/0	Light Truck	50	2
9263	6/0	Medium Truck	50	4
9273	7/0	Heavy Truck	50	5
9280	9/0	3/8" Square Link	50	8
9282	11/0	7/16" Square Link	50	13
9284	14/0	1/2" Square Link	50	22



SIDE CHAIN REPAIR LINKS

Stock No.	Chain Dia.	Inside Length	Application	Std. Pkg.	Wt./Pkg.
9116A	7/32"	1-1/4"	Passenger Car	50	2
9116B	1/4"	1-1/4"	Light Truck	50	3
9116C	5/16"	1-1/2"	Medium Truck / Truck	50	7
9116D	3/8"	1-5/8"	Grader	50	11
9116E	7/16"	2-1/2"	Loader	10	3
9116F	1/2"	3-1/4"	Giant OTR	10	5



LINK REPAIR RING (TO REPAIR NET, DIAMOND BACK)

Stock No.	Ring Diameter	Inside Length	Std. Pkg.	Wt./Pkg.
RING-6	1/4"	1.5"	1	1
RING-13	1/2"	2"	1	1
RING-16	5/8"	3"	1	1



QUICK LINKS

Fast, easy connections for permanent or temporary attachment. Applications with low carbon chain only. Bright zinc finish.

[FIND PRICING IN JOBBER ON WEBSITE](#)

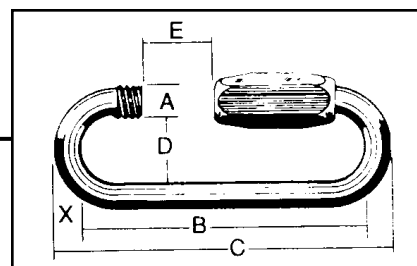

STOCK NO.	TRADE SIZE		DIMENSIONS, INCHES					WEIGHT/EACH	LIMIT/LBS.	PIECES PER BAG
	INCH.	MM	A	B	C	D	E			
QL125	1/8"	3.5	0.188	1.125	1.375	0.375	0.188	0.02	220	10
QL192	3/16"	5.0	0.281	1.500	1.875	0.500	0.250	0.04	610	10
QL281	1/4"	6.0	0.375	1.750	2.250	0.563	0.281	0.08	880	10
QL312	5/16"	8.0	0.500	2.313	2.875	0.688	0.375	0.16	1540	10
QL375	3/8"	9.0	0.500	2.438	3.125	0.750	0.438	0.24	1980	10
QL437	7/16"	10.0	0.531	2.688	3.500	0.813	0.500	0.38	2920	10
QL531	1/2"	12.0	0.594	3.188	4.125	0.938	0.625	0.56	3300	10

SHACKLES

(Galvanized Screw Pin)

Stock No.	Diameter
SGC250	1/4"
SGC312	5/16"
SGC375	3/8"
SGC437	7/16"
SGC531	1/2"
SGC625	5/8"



(PIN COUPLER SHACKLE)

Stock No.	Diameter
PCS-250	1/4" 6 MM
PCS-312	5/16" 8 MM
PCS-375	3/8" 10 MM
PCS-531	1/2" 13 MM
PCS-625	5/8" 16 MM
PCS-750	3/4" 19 MM



(Alloy Screw Pin)

SAC437	7/16"
SAC531	1/2"
SAC625	5/8"
SAC750	3/4"



T AND L HANDLES

Stock No.	Description
T2800	Heavy Truck T
T2801	Light Truck T
L2800	Heavy Truck L
L2801	Light Truck L
TC-TOOL	Heavy Truck L



COLD SHUTS

FIND PRICING IN JOBBER ON WEBSITE

STOCK NO.	TRADE SIZE INCHES	INSIDE LENGTH	INSIDE WIDTH	WEIGHT/EACH	PIECES PER BAG	WORKING LOAD
CS192	3/16"	1-5/16"	11/32"	.02	10	450
CS281	1/4"	1-3/16"	3/8"	.04	10	750
CS312	5/16"	1-3/8"	7/16"	.10	10	1250
CS375	3/8"	1-1/2"	5/8"	.16	10	1900



SNAP HOOKS

Fast, easy connections for temporary attachment. Applications with low carbon chain only. Bright zinc finish.

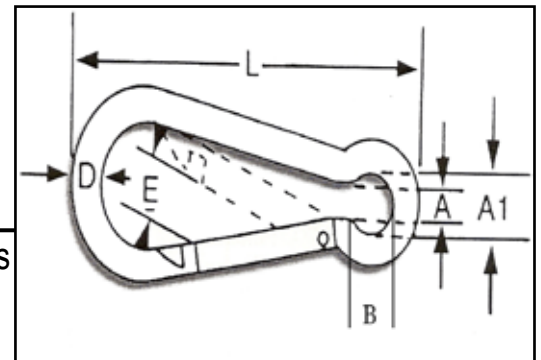

FIND PRICING IN JOBBER ON WEBSITE

STOCK NO.	TRADE SIZE		DIMENSIONS, IN "MM"					WEIGHT/EACH	LIMIT/LBS.	PIECES PER BAG
	INCH.	MM (D)	A1	A	B	E	L			
SH440	5/32"	4.0	9	5	6.5	7	40	.02	990	10
SH550	3/16"	5.0	10	6	7.5	8	50	.04	1254	10
SH660	1/4"	6.0	13	8	9.0	9	60	.06	1474	10
SH770	9/32"	7.0	13	8	10.0	9	70	.10	1650	10
SH880	5/16"	8.0	13	8	11.5	9	80	.14	1914	10
SH990	3/8"	9.0	14	8	13.0	9	90	.20	2090	10
SH1010	11/32"	10.0	15	12	15.0	13	100	.26	2090	10
SH1112	7/16"	11.0	18	14	19.0	15	120	.40	2310	10
SH1214	15/32"	12.0	20	13	18.0	19	140	.56	2816	10
SH1316	1/2"	13.0	22	14	20.0	26	160	.78	2970	10
SH1418	17/32"	14.0	25	21	25.0	32	180	.98	2980	10
SH1520	9/16"	15.0	25	21	25.0	40	200	1.20	3110	10

ACCESSORIES

SPIDER BUNGEEES

Stock No.	Adjuster Type	Application	Std. Pkg.	Wt./Pr.
0212	SPIDER Rubber	Passenger	30 PR.	1

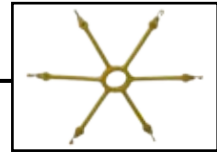

0216	SPIDER Rubber	Light Truck	30 PR.	1
------	---------------	-------------	--------	---

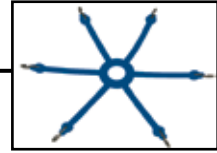

0218	H.D. SPIDER Rubber	Truck	30 PR.	1.8
------	--------------------	-------	--------	-----



0220	H.D. SPIDER Rubber	Light Loader/Tractor	20 PR.	3
------	--------------------	----------------------	--------	---

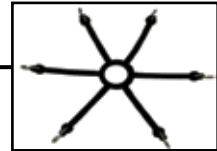

0213	SPIDER Rubber	Passenger	30 PR.	1
------	---------------	-----------	--------	---

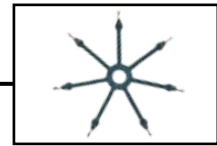

For A1000 Series Passenger Cable, ATV, Garden Tractor, Snow Blower

0217	SPIDER Rubber	Light Truck	30 PR.	1.1
------	---------------	-------------	--------	-----

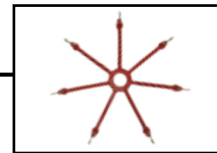

For A2000 Series Light Truck Cable Chains

Stock No.	Adjuster Type	Application	Std. Pkg.	Wt./Pkg.
0214	RA1 / Rubber	Passenger Car	30 PR.	15
0225	RA10 / Rubber	Light Truck	30 PR.	18
0229	RA20 / Rubber	Heavy Truck	30 PR.	30
0238	H.D. Rubber	Passenger & LT	30 PR.	24
0239	H.D. Rubber	LT & Truck	30 PR.	26

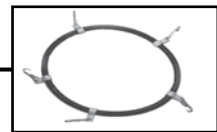

0272	#2 / Spring	Light Truck	1 PR.	2
------	-------------	-------------	-------	---

0273	#3 / Spring	Heavy Truck	1 PR.	6
------	-------------	-------------	-------	---

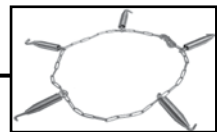

0294	Link / Shackle	Large Chain	EACH	5
------	----------------	-------------	------	---

0296	Link / Shackle	Giant Chain	EACH	12
------	----------------	-------------	------	----

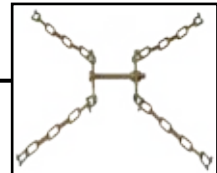

**CHAIN HANGER
CH-1**



**NO DRILL CHAIN
HANGER BRACKET
PART# CHB-1**

RUBBER BUNGEE STRAPS



Stock No.	Strap Size	Std. Pkg.
0209	9 Inch Strap	50
0215	15 Inch Strap	50
0221	21 Inch Strap	50
0231	31 Inch Strap	50

SHOE CHAIN

FIND PRICING IN JOBBER ON WEBSITE

FOR BOOTS, ADD ONE SIZE TO YOUR SHOE SIZE

Stock No.	Description	Men's Shoe Size	Women's Shoe Size
SCM	Medium Shoe Chain	5-9	6-10
SCL	Large Shoe Chain	9.5-12.5	10.5-up
SCXL	X-Large Shoe Chain	13-up	N/A



SHOE CHAIN SPIKES

FIND PRICING IN JOBBER ON WEBSITE

Stock No.	Description	Wt./Pr.	Shoe Size
SC-SPIKES	UNIVERSAL SPIKE TYPE SHOE CHAIN	.3	ONE SIZE FITS ALL



REPLACEMENT CROSS CHAINS

Stock No.	Std. Pkg.	Wt./Pkg.	Link Wire Diameter	No. Links	Hook Wire Diameter	Hook Stock No.	Inside Length w/ Hooks (Inch)
2561-2596	1	2	3/0 .207		7/32" .218	20250	18.63"
5214	25	6	3/0 .207	7	13/64" .207	20230	10.18"
5220	25	8	3/0 .207	9	13/64" .207	20230	12.02"
5222	25	9	3/0 .207	10	13/64" .207	20230	12.94"
5224	25	11	3/0 .207	12	13/64" .207	20230	13.86"
5414	25	5	1/0 .177	7	11/64" .177	20177	10.38"
5414SL	25	6	2/0 .192	7	11/64" .177	20177	10.38"
5419	25	6	1/0 .177	8	11/64" .177	20177	11.56"
5419SL	25	6	2/0 .192	8	11/64" .177	20177	11.56"
5420	25	7	1/0 .177	9	11/64" .177	20177	12.74"
5420SL	25	7	2/0 .192	9	11/64" .177	20177	12.74"
5422	25	7	1/0 .177	10	11/64" .177	20177	13.92"
5422SL	25	8	2/0 .192	10	11/64" .177	20177	13.92"
5814	25	8	3/0 .207	7	13/64" .207	20230	10.18"
5820	25	9	3/0 .207	9	13/64" .207	20230	12.02"
5822	25	12	3/0 .207	10	13/64" .207	20230	12.94"
5824	25	13	3/0 .207	11	13/64" .207	20230	13.86"
6218	25	12	4/0 .218	8	1/4" .250	20250	11.12"
6219	25	12	4/0 .218	9	1/4" .250	20250	12.12"
6221	25	12	4/0 .218	10	1/4" .250	20250	13.24"
A6221	25	12	4/0 .218	10	1/4" .250	A20250N	13.24"

REPLACEMENT CROSS CHAINS

Stock No.	Std. Pkg.	Wt./Pkg.	Link Wire Diameter	No. Links	Hook Wire Diameter	Hook Stock No.	Inside Length w/ Hooks (Inch)
6221LM	25	15	4/0 .218	10	1/4" .250	20250	13.24"
6221SL	25	19	4/0 .218	11	5/16" .312	20312	14.18"
6221SLN	25	19	4/0 .218	11	5/16" .312	20312	14.00"
6221DBT	1	2	4/0 .218	14	1/4" .250	A20250N	14.25"
6221DB	1	2	4/0 .218	14	1/4" .250	20250	14.25"
6223	25	14	4/0 .218	11	5/16" .312	20312	14.08"
6225	25	16	4/0 .218	12	1/4" .250	20250	15.12"
6225T	25	16	4/0 .218	12	1/4" .250	A20250N	15.12"
6225LM	25	17	4/0 .218	12	1/4" .250	20250	15.12"
6225SL	25	17	4/0 .218	13	5/16" .312	20312	15.40"
6225SLN	25	17	4/0 .218	13	5/16" .312	20312	15.87"
6225DBT	1	3	4/0 .218	17	1/4" .250	A20250N	15.50"
6225DB	1	3	4/0 .218	17	1/4" .250	20250	15.50"
6229	25	19	4/0 .218	14	5/16" .312	20312	17.10"
6229 HP	1	4	4/0 .218	14	1/4" .250	20250	17.13"
6233	25	31	7/0 .312	9	5/16" .312	20312	16.01"
6250SL	25	23	6/0 .281	9	5/16" .312	A20312N	14.00"
6251	25	23	6/0 .281	9	5/16" .312	20312	14.37"
A6251	25	23	6/0 .281	9	5/16" .312	A20312N	14.37"
6251LM	25	23	6/0 .281	9	5/16" .312	20312	14.37"
6251ST	25	31	6/0 .281	9	3/8" .375	A20375N	14.60"
6251SLN	25	34	6/0 .281	9	3/8" .375	A20375N	14.40"
6251SLX	25	35	6/0 .281	9	3/8" .375	A20375N	15.12"
6251SL	25	31	6/0 .281	9	3/8" .375	A20375N	14.60"
6251SL TWIST	25	34	6/0 .281	9	3/8" .375	A20375N	14.40"
6251ST	1	1	4/0 .218	11	1/4" .250	A20250N	15.75"
6252ST	1	1	4/0 .218	13	1/4" .250	A20250N	16.75"
A6253	25	25	6/0 .281	10	5/16" .312	A20312N	15.62"
A6253SLN	25	33	6/0 .281	11	3/8" .375	A20375N	16.75"
6253	25	25	6/0 .281	10	5/16" .312	20312	15.62"
6253LM	25	25	6/0 .281	10	5/16" .312	20312	15.62"
6253SL	25	33	6/0 .281	11	3/8" .375	A20375N	16.75"
6253SL TWIST	25	28	6/0 .281	10	3/8" .375	A20375N	15.62"
6253ST	1	1	4/0 .218	16	1/4" .250	A20250N	19.50"
6254ST	1	2	4/0 .218	18	1/4" .250	A20250N	21.50"
6255	25	28	7/0 .312	7	5/16" .312	A20312N	12.00"
6256	25	30	7/0 .312	8	3/8" .375	20375	14.62"
6256HH	25	33	7/0 .312	8	13/32" .406	20406	14.62"
6256T	25	30	7/0 .312	8	3/8" .375	A20375N	14.62"
6258	25	25	6/0 .281	11	3/8" .375	A20375N	17.25"
6258HP			6/0 .281	12	5/16" .312	20312	18.25"
6259	25	27	6/0 .281	12	5/16" .312	20312	18.12"
6259LM	25	28	6/0 .281	12	5/16" .312	A20312N	18.12"
6259SL	25	39	6/0 .281	13	3/8" .375	A20375N	19.08"
6260	25	34	7/0 .312	9	3/8" .375	20375	16.01"
6260HH	25	36	7/0 .312	9	13/32" .406	20406	16.01"
6260LM	25	35	7/0 .312	9	3/8" .375	20375	16.01"
6260SL	25	44	7/0 .312	9	3/8" .375	A20375N	15.62"
6260SL TWIST	25	45	7/0 .312	9	3/8" .375	A20375N	16.50"
6263	25	40	7/0 .312	10	3/8" .375	20375	17.40"

REPLACEMENT CROSS CHAINS

Stock No.	Std. Pkg.	Wt./Pkg.	Link Wire Diameter	No. Links	Hook Wire Diameter	Hook Stock No.	Inside Length w/ Hooks (Inch)
6263LM	25	43	7/0 .312	10	3/8" .375	20375	17.40"
6263SL	25	46	7/0 .312	11	3/8" .375	A20375N	17.00"
6263SL TWIST	25	46	7/0 .312	11	3/8" .375	20375	17.50"
6263SLX	25	48	7/0 .312	11	3/8" .375	A20375NL	18.10"
6265	25	39	6/0 .281	16	3/8" .375	20375	23.12"
6266	25	36	7/0 .312	11	3/8" .375	20375	18.79"
6267	25	35	6/0 .281	17	5/16" .312	20312	24.37"
6268	25	39	7/0 .312	12	3/8" .375	20375	20.36"
6268SL	25	54	7/0 .312	13	3/8" .375	A20375N	20.50"
6434	25	54	9/0 .375	11	13/32" .406	20406	17.36"
6434HH	25	57	9/0 .375	11	7/16" .437	20437	17.36"
6434N	25	54	9/0 .375	11	13/32" .406	A20406N	17.36"
6436	25	57	9/0 .375	12	13/32" .406	20406	18.75"
6438	25	61	9/0 .375	13	13/32" .406	20406	20.50"
6438HH	25	64	9/0 .375	13	7/16" .437	20437	20.50"
6438N	25	61	9/0 .375	13	13/32" .406	A20406N	20.50"
6445	25	66	9/0 .375	14	13/32" .406	20406	21.14"
E6520S	25	62	7/0 .312	17	13/32" .406	A20406N	27.00"
E6520N	25	62	7/0 .312	17	13/32" .406	A20406N	26.00"
E6530S	5	17	9/0 .375	17	7/16" .437	A20437N	26.50"
E6530N	5	17	9/0 .375	15	7/16" .437	A20437N	25.75"
E6540S	5	19	9/0 .375	19	7/16" .437	A20437N	29.00"
E6540SH	5	31	11/0 .437	17	1/2" .531	A20531N	32.25"
E6540N	5	31	11/0 .437	17	1/2" .531	A20531N	32.00"
E6550S	5	38	9/0 .375	23	7/16" .437	A20437N	33.98"
E6550N	5	33	11/0 .437	19	1/2" .531	A20531N	35.50"
E6550SH	5	33	11/0 .437	19	1/2" .531	A20531N	35.50"
E6560S	5	42	11/0 .437	19	1/2" .531	A20531N	39.25"
E6560N	5	51	14/0 .531	19	1/2" .531	A20531N	39.00"
E6560SH	5	51	14/0 .531	21	1/2" .531	A20531N	39.30"
E6570S	5	51	11/0 .437	25	1/2" .531	A20531N	44.75"
E6570N	5	69	14/0 .531	25	1/2" .531	A20531N	44.50"
E6570SH	5	69	14/0 .531	25	1/2" .531	A20531N	44.75"
E6580S	5	62	11/0 .437	29	1/2" .531	A20531N	52.00"
E6580N	5	84	14/0 .531	29	1/2" .531	A20531N	52.00"
E6580SH	5	84	14/0 .531	29	1/2" .531	A20531N	52.00"
6630	10	31	9/0 .375	17	13/32" .406	20406	25.00"
6630N	10	31	9/0 .375	17	13/32" .406	A20406N	25.00"
6640	10	44	11/0 .437	15	7/16" .437	20437	28.00"
6640N	10	44	11/0 .437	15	7/16" .437	A20437N	28.00"
6650	10	53	11/0 .437	19	7/16" .437	20437	34.40"
6650N	10	53	11/0 .437	19	7/16" .437	A20437N	34.40"
6655	5	55	11/0 .437	21	7/16" .437	20437	36.50"
6660	5	48	14/0 .531	19	1/2" .531	A20531N	39.30"
6660N	5	48	14/0 .531	19	1/2" .531	A20531N	39.30"
6670	5	54	14/0 .531	22	1/2" .531	A20531N	44.50"
6670N	5	54	14/0 .531	22	1/2" .531	A20531N	44.50"
6680	5	63	14/0 .531	26	1/2" .531	A20531N	51.50"
6680N	5	63	14/0 .531	26	1/2" .531	A20531N	51.50"
6751	25	29	6/0 .281	9	5/16" .312	20312	14.37"

REPLACEMENT CROSS CHAINS

Stock No.	Std. Pkg.	Wt./Pkg.	Link Wire Diameter	No. Links	Hook Wire Diameter	Hook Stock No.	Inside Length w/ Hooks (Inch)
6753	25	28	6/0 .281	10	5/16" .312	20312	15.64"
6760	25	42	7/0 .312	9	3/8" .375	20375	16.01"
6763	25	41	7/0 .312	10	3/8" .375	20375	17.40"
6734	25	54	9/0 .375	11	13/32" .406	20406	17.36"
6736	25	57	9/0 .375	12	13/32" .406	20406	18.75"
6818	25	13	4/0 .218	8	1/4" .218	20250	11.12"
6819	25	15	4/0 .218	9	1/4" .218	20250	12.12"
6821	25	17	4/0 .218	10	1/4" .218	20250	13.12"
6822	25	28	6/0 .281	9	5/16" .312	20312	14.37"
6823	25	17	4/0 .218	11	1/4" .250	20250	14.08"
6825	25	20	4/0 .218	12	1/4" .250	20250	15.12"
6827	25	21	4/0 .218	14	1/4" .250	20250	17.10"
6829 HP	1	4.5	4/0 .218	14	1/4" .250	20250	17.00"
6858 HP	1	6	7/0 .312	12	5/16" .312	20312	18.25"
6830	10	34	9/0 .375	17	13/32" .406	20406	25.00"
6853	25	28	6/0 .281	10	5/16" .312	20312	15.64"
6858	25	25	6/0 .281	11	3/8" .375	20375	17.25"
6859	25	30	6/0 .281	12	5/16" .312	20312	18.12"
6860	25	42	7/0 .312	9	3/8" .375	20375	16.01"
6863	25	41	7/0 .312	10	3/8" .375	20375	17.40"
6864	25	34	7/0 .312	13	3/8" .375	20375	21.69"
6865	25	41	6/0 .281	16	3/8" .375	20375	23.12"
6866	25	44	7/0 .312	11	3/8" .375	20375	18.79"
6905	25	30	5/0 .250	11	5/16" .312	A20312N	12.25"
6906	25	32	5/0 .250	12	5/16" .312	A20312N	13.32"
6909	25	24	6/0 .281	9	5/16" .312	A20344N	12.60"
6912	25	28	6/0 .281	10	5/16" .312	A20344N	13.60"
6913	25	30	6/0 .281	11	5/16" .312	A20344N	14.60"
6914	25	32	6/0 .281	12	5/16" .312	A20344N	15.70"
6915	25	34	6/0 .281	13	5/16" .312	A20344N	16.70"
6916	25	35	6/0 .281	14	5/16" .312	A20344N	17.70"
6917	25	37	6/0 .281	15	5/16" .312	A20344N	18.71"
6922	25	43	7/0 .312	10	3/8" .375	A20375N	14.99"
6923	25	42	7/0 .312	11	3/8" .375	A20375N	15.74"
6924	25	44	7/0 .312	12	3/8" .375	A20375N	16.50"
6925	25	51	7/0 .312	13	3/8" .375	A20375N	19.00"
6927	10	27	9/0 .375	9	7/16" .437	A20437N	17.00"
6928	10	29	9/0 .375	10	7/16" .437	A20437N	18.75"
6929	10	34	9/0 .375	12	7/16" .437	A20437N	21.30"
6930	10	38	9/0 .375	14	7/16" .437	A20437N	24.16"
6935	10	42	11/0 .437	11	1/2" .531	A20531N	17.40"
6940	10	45	11/0 .437	15	1/2" .531	A20531N	27.74"
6950	10	67	11/0 .437	19	1/2" .531	A20531N	36.40"
6960	5	53	14/0 .531	17	1/2" .531	A20531N	39.11"
6905N	25	30	5/0 .250	11	5/16" .312	A20312N	12.25"
6906N	25	32	5/0 .250	12	5/16" .312	A20312N	13.32"
6909N	25	24	6/0 .281	9	5/16" .312	A20344N	12.60"
6912N	25	28	6/0 .281	10	5/16" .312	A20344N	13.60"
6913N	25	30	6/0 .281	11	5/16" .312	A20344N	14.60"
6914N	25	32	6/0 .281	12	5/16" .312	A20344N	15.70"

CROSS CHAIN

REPLACEMENT CROSS CHAINS

Stock No.	Std. Pkg.	Wt./Pkg.	Link Wire Diameter	No. Links	Hook Wire Diameter	Hook Stock No.	Inside Length w/ Hooks (Inch)
6915N	25	34	6/0 .281	13	5/16" .312	A20344N	16.70"
6916N	25	35	6/0 .281	14	5/16" .312	A20344N	17.70"
6917N	25	37	6/0 .281	15	5/16" .312	A20344N	18.71"
6922N	25	43	7/0 .312	10	3/8" .375	A20375N	14.99"
6923N	25	42	7/0 .312	11	3/8" .375	A20375N	15.74"
6924N	25	44	7/0 .312	12	3/8" .375	A20375N	16.50"
6925N	25	51	7/0 .312	13	3/8" .375	A20375N	19.00"
6927N	10	27	9/0 .375	9	7/16" .437	A20437N	17.00"
6928N	10	29	9/0 .375	10	7/16" .437	A20437N	18.75"
6929N	10	34	9/0 .375	12	7/16" .437	A20437N	21.30"
6930N	10	38	9/0 .375	14	7/16" .437	A20437N	24.16"
6935N	10	42	11/0 .437	11	1/2" .531	A20531N	17.40"
6940N	10	45	11/0 .437	15	1/2" .531	A20531N	27.74"
6950N	10	67	11/0 .437	19	1/2" .531	A20531N	36.40"
6960N	5	53	14/0 .531	17	1/2" .531	A20531N	39.11"
6970N	5	59	14/0 .531	23	1/2" .531	A20531N	44.50"
6980N	5	69	14/0 .531	27	1/2" .531	A20531N	51.50"
7213	25	43	7/0 .312	13	3/8" .375	20375	21.57"
7213SL	25	52	7/0 .312	13	3/8" .375	A20375N	21.57"
7214	25	45	7/0 .312	14	3/8" .375	20375	22.96"
7215	25	48	7/0 .312	15	3/8" .375	20375	24.35"
7216	25	60	7/0 .312	20	3/8" .375	20375	31.30"
7419SL	10	31	9/0 .375	13	7/16" .437	A20437N	21.30"
7420	10	29	9/0 .375	16	13/32" .406	20406	23.66"
7426	10	33	9/0 .375	19	13/32" .406	20406	27.44"
7462XD	25	41	7/0 .312	8	3/8" .375	20375	14.62"
7464XD	25	44	7/0 .312	9	3/8" .375	20375	16.01"
7465XD	25	34	7/0 .312	10	3/8" .375	20375	17.40"
8501	5	40	9/0 .375	14	7/16" .437	A20437N	26.00"
8502	5	53	9/0 .375	16	7/16" .437	A20437N	29.10"
8503	5	64	11/0 .437	15	7/16" .437	A20437N	28.70"
8504	5	70	11/0 .437	17	1/2" .531	A20531N	32.90"
8505	5	72	11/0 .437	19	1/2" .531	A20531N	36.10"
8506	1	16	11/0 .437	21	1/2" .531	A20531N	39.30"
8507	1	20	14/0 .531	15	1/2" .531	A20531N	35.60"
8508	1	20	14/0 .531	17	1/2" .531	A20531N	39.60"
8509	1	24	14/0 .531	19	1/2" .531	A20531N	43.60"
8510	1	26	14/0 .531	20	1/2" .531	A20531N	45.60"
8511	1	27	14/0 .531	21	1/2" .531	A20531N	47.60"
8825	25	9		25			16.50"
8901	1	8	9/0 .375	13	7/16" .437	A20437N	26.00"
8902	1	10	9/0 .375	15	7/16" .437	A20437N	29.08"
8903	1	14	11/0 .437	15	1/2" .531	A20531N	29.74"
8904	1	16	11/0 .437	17	1/2" .531	A20531N	32.98"
8905	1	17	11/0 .437	19	1/2" .531	A20531N	36.21"
8906	1	18	11/0 .437	21	1/2" .531	A20531N	39.44"
8907	1	20	14/0 .531	15	1/2" .531	A20531N	35.66"
8908	1	21	14/0 .531	17	1/2" .531	A20531N	39.68"
8909	1	25	14/0 .531	19	1/2" .531	A20531N	43.69"
8911	1	26	14/0 .531	21	1/2" .531	A20531N	47.71"

WELDED CHAIN



SYSTEM 3 (PROOF COIL CHAIN)

Made from low carbon steel, used as a general utility chain.

FULL DRUM

BRIGHT ZINC FINISH [FIND PRICING IN JOBBER ON WEBSITE](#)

Stock Number	Trade Size		Wire Dia.	Pounds Per 100 Feet	Feet/Drum	Working Load Limit	
	Inches	MM				LBS.	KGS.
G301CBF-200	1/4"	7.0	.281	76	800	1250	567
G305CBF-200	5/16"	8.0	.343	102	550	1900	882
G303CBF-200	3/8"	10.0	.399	142	400	2650	1200
G3016CBF-200	3/16"	5.5	.218	41	800	750	340

HOT DIP GALVANIZED FINISH

Stock Number	Trade Size		Wire Dia.	Pounds Per 100 Feet	Feet/Drum	Working Load Limit	
	Inches	MM				LBS.	KGS.
G301CBF-300	1/4"	7.0	.281	76	800	1250	567
G305CBF-300	5/16"	8.0	.343	102	550	1900	882
G303CBF-300	3/8"	10.0	.399	142	400	2650	1200

SYSTEM 4 (HIGH TEST CHAIN)

Made from medium grade carbon steel. Use for such applications as wrecking and boomer chain.

FULL DRUM

SELF COLORED FINISH [FIND PRICING IN JOBBER ON WEBSITE](#)

Stock Number	Trade Size		Wire Dia.	Pounds Per 100 Feet	Feet/Drum	Working Load Limit	
	Inches	MM				LBS.	KGS.
G431CBF-100	1/4"	7.0	.281	75	800	2600	1180
G435CBF-100	5/16"	8.0	.343	115	550	3900	1770
G433CBF-100	3/8"	10.0	.399	270	400	5400	2450

BRIGHT ZINC FINISH

Stock Number	Trade Size		Wire Dia.	Pounds Per 100 Feet	Feet/Drum	Working Load Limit	
	Inches	MM				LBS.	KGS.
G431CBF-200	1/4"	7.0	.281	75	800	2600	1180
G435CBF-200	5/16"	8.0	.343	115	550	3900	1770
G433CBF-200	3/8"	10.0	.399	270	400	5400	2450

HOT DIP GALVANIZED FINISH

Stock Number	Trade Size		Wire Dia.	Pounds Per 100 Feet	Feet/Drum	Working Load Limit	
	Inches	MM				LBS.	KGS.
G431CBF-300	1/4"	7.0	.281	75	800	2600	1180
G435CBF-300	5/16"	8.0	.343	115	550	3900	1770
G433CBF-300	3/8"	10.0	.399	270	400	5400	2450

*****NOT FOR OVERHEAD LIFTING*****

SYSTEM 7 (TRANSPORT CHAIN)

Meets Department Of Transportation requirements for use as truck tie downs, lumbering, towing, etc.

FULL DRUM

YELLOW ZINC FINISH

[FIND PRICING IN JOBBER ON WEBSITE](#)

Stock Number	Trade Size		Wire Dia.	Pounds Per 100 Feet	Feet/Drum	Working Load Limit	
	Inches	MM				LBS.	KGS.
G705CBF	5/16"	8.0	.343	115	550	4700	2130
G703CBF	3/8"	10.0	.399	160	400	6600	2990
G702CBF	1/2"	13.0	.531	268	200	11300	5136

SYSTEM 8 (TRANSPORT CHAIN)

FULL DRUM

SELF COLORED FINISH

[FIND PRICING IN JOBBER ON WEBSITE](#)

Stock Number	Trade Size		Wire Dia.	Pounds Per 100 Feet	Feet/Drum	Working Load Limit	
	Inches	MM				LBS.	KGS.
G801CBF	1/4"	6.0	.250	68	900	2100	954
G802CBF	1/2"	13.0	.531	263	200	12000	5444
G803CBF	3/8"	10.0	.399	151	400	7100	3221
G805CBF	5/16"	8.0	.343	97	550	4500	2042
G809CBF	9/32"	7.0	.281	72	800	3500	1588

Warning: Do not exceed working load limit or use for overhead lifting. Catalog weights are approximate.

CHAIN ASSEMBLIES

SYSTEM 7 (TRANSPORT CHAIN)

with 2 clevis grab hooks

YELLOW ZINC FINISH

[FIND PRICING IN JOBBER ON WEBSITE](#)

Stock Number	Chain Size	Pounds Per Piece	Pieces Per Drum	Working Load Limit	
				LBS.	KGS.
G70516	5/16"X16'	17.6	30	4700	2130
G70520	5/16"X20'	23.7	25	4700	2130
G70525	5/16"X25'	30	20	4700	2130
G70316	3/8"X16'	25.8	20	6600	2990
G70320	3/8"X20'	31.8	20	6600	2990
G70220	1/2"X20'	52	10	11300	5136
G70225	1/2"X25'	64	10	11300	5136



SYSTEM 4 (HIGH TEST CHAIN)

with 2 clevis grab hooks

BRIGHT ZINC FINISH

[FIND PRICING IN JOBBER ON WEBSITE](#)

Stock Number	Chain Size	Pounds Per Piece	Pieces Per Drum	Working Load Limit	
				LBS.	KGS.
G43520-200	5/16"X20'	21.6	25	3900	1770
G43320-200	3/8"X20'	31.9	20	5400	2450



SYSTEM 3 (PROOF COIL CHAIN)

with 2 safety latch "S" hooks

BRIGHT ZINC FINISH

[FIND PRICING IN JOBBER ON WEBSITE](#)

Stock Number	Chain Size	Pounds Per Piece	Pieces Per Drum	Working Load Limit	
				LBS.	KGS.
G301S5-200	1/4"X5'	3.5	10	1250	567
G305S5-200	5/16"X5'	5.4	10	1900	862



ACCESSORIES

SYSTEM 3 (SAFETY LATCH "S" HOOKS, CLIP TYPE)

For trailer safety chain

BRIGHT ZINC FINISH

FIND PRICING IN JOBBER ON WEBSITE

Stock Number	Trade Size		Pounds Per Piece	Pieces Per Bag	Working Load Limit	
	Inches	MM			LBS.	KGS.
G301SH	7/16"	11.1	.4	10	1250	567
G305SH	17/32"	13.5	.6	10	1900	862



SYSTEM 7 (CLEVIS GRAB HOOK)

YELLOW ZINC FINISH

Stock Number	Pounds Per Piece	Pieces Per Bag	Working Load LBS.
Grab 1/4	.4	10	3600
Grab 5/16	.8	10	5400
Grab 3/8	1.0	10	7500
Grab 1/2	2.1	10	12500



BINDERS

FIND PRICING IN JOBBER ON WEBSITE

Stock Number	Description	Weight Per Piece	Pieces Per Package	Working Load LBS.
BLT1	1/4" Double Swivel	3.7	1	2600
BLT5	5/16" - 3/8" Double Swivel	8.4	1	5400
BLT3	3/8" - 1/2" Double Swivel	13.1	1	9200



Stock Number	Description	Weight Per Piece	Pieces Per Package	Working Load LBS.
BRT5	5/16" - 3/8" Ratchet	11.8	1	5400
BRT3	3/8" - 1/2" Ratchet	12.6	1	9200
BRT2	1/2" - 5/8" Ratchet	15	1	13000



SYSTEM 7 MID-LINKS

YELLOW ZINC FINISH

FIND PRICING IN JOBBER ON WEBSITE

Stock Number	For Chain Size	Pounds Per Piece	Pieces Per Bag	Working Load LBS.
MID 312-7	1/4" - 5/16"	.53	10	4700
MID 375-7	3/8"	.81	10	6600
MID 531-7	7/16" - 1/2"	1.68	10	11300



DOUBLE LOOP

A general utility chain for hardware and manufacturing applications such as playground and gym equipment, fluorescent lights, boats, gates, porch swings, halter, cow ties and tie-out chains.

Stock Number	Pieces Per Package	Length Per Piece	Weight Per Piece
DBL-LOOP-30	50	30"	0.27



NOT FOR OVERHEAD LIFTING

PACKAGING OPTIONS



Passenger / LT Volt Box



Passenger Box



1000, 1600 & 2300 Series Bag



2300 Series Cobra Cable Box



1600 Series Cobra Jr. Cable Box



Volt Truck Box

WIRE DIAMETER CROSS REFERENCE CHART

Nominal weights and dimensions are subject to tolerance of plus or minus 4%.

TRADE SIZE	GAUGE	FRACTIONAL	METRIC
1/0	.177	11/64"	4.50 MM
2/0	.192	3/16"	4.80 MM
3/0	.207	13/64"	5.20 MM
4/0	.218	7/32"	5.54 MM
5/0	.250	1/4"	6.35 MM
6/0	.281	9/32"	7.00 MM
7/0	.312	5/16"	8.00 MM
8/0	.344	11/32"	9.00 MM
9/0	.375	3/8"	9.50 MM
10/0	.406	13/32"	10.30 MM
11/0	.437	7/16"	11.10 MM
13/0	.500	1/2"	12.70 MM
14/0	.531	17/32"	13.50 MM

STOCK	PRICE
Bay Banners	\$25.00
Window Banners	\$2.00
Brochures (Quick Trak)	\$1.00
Other Brochures	\$1.00
30 MPH Sign 12"x18"	N/C
Catalogs	N/C
Boxes	Call For Pricing
Bags	Call For Pricing

DEFINITIONS OF SAE CLASSIFICATIONS

1. SAE Class "S" — Regular (non-reinforced) passenger tire chains and cables for vehicles with restricted wheel well clearances.
2. SAE Class "U" — Regular (non-reinforced) and lug reinforced passenger tire chains for vehicles with regular (non-restricted) wheel well clearances.
3. SAE Class "W" — Those passenger tire chains that use light truck components, as well as some light truck chains.

ISO 9002
CERTIFIED

MINIMUM CLEARANCES REQUIRED FOR TIRE CHAINS

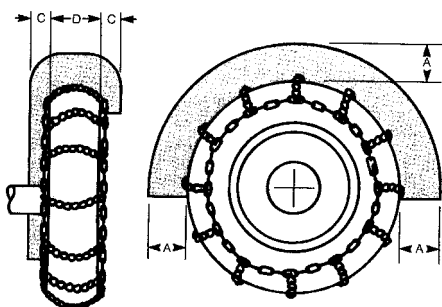

PASSENGER CAR AND LIGHT TRUCK TIRES

TIRE CHAIN IDENTIFICATION	THREE ENVELOPES	MINIMUM DIMENSIONS
	A	C
SAE CLASS "S"	1.46" (37 MM)	.59" (15 MM)
SAE CLASS "U"	1.97" (50 MM)	.91" (23 MM)
SAE CLASS "W"	2.50" (63.5 MM)	1.50" (38.1 MM)

NOTE: For design purposes, "D" is the maximum crown tire section width as established by the Tire and Rim Association (TRA). The minimum clearances specified must be maintained around spring clips, spring bolts, fenders, braces, splash pans, fuel lines, brake lines, brake controls, and wherever necessary.

Tire size must be known in order to select a tire chain of correct fit. For passenger cars, vans and small pick-up trucks it is important to check the owner's manual. The restricted wheel clearances in most of today's downsized and front drive vehicles may require the use of SAE Class "S" tire chains, as noted in the manuals.

For tire sizes or other products not listed call 503-614-9664